



Trimble® Earthworks Dozer

Version 2.12.x
Revision A
February 2023

Contents

1	Controls and Guidance	7
1.1	Viewing Licenses	8
1.1.1	License types	8
1.1.2	Status icons	9
1.1.3	License information	9
1.2	Joystick Configuration for Cat D5–D7 machines	10
1.3	On-screen Lightbars	10
1.3.1	The Lightbars screen	11
1.3.2	Understanding lightbar information	11
1.3.3	Useful text items	13
1.3.4	System buzzer	13
1.3.5	Troubleshooting	13
1.4	External Lightbars	13
1.4.1	The Lightbars screen	14
1.4.2	External lightbar behavior	14
1.4.3	Useful text items	15
1.4.4	System buzzer	15
1.4.5	Troubleshooting	15
1.5	Transferring Files	16
1.5.1	File categories	16
1.5.2	File structure for external storage devices	17
1.5.3	Syncing files with the Connected Community	17
1.5.4	Transferring files via an external storage device	18
1.5.5	Importing files to your machine	19
1.5.6	Exporting files from the machine	20
1.5.7	Using custom file import	20
1.5.8	Troubleshooting	20
1.5.9	System operation in Android 11	21
1.6	Network	22
2	Using 2D Positioning Sources	23
2.1	Using Lasers	24
2.1.1	Select sensor combination	24
2.1.2	Bench Laser Receiver	25
2.1.3	Set an Elevation Offset	27
2.1.4	Linked Elevation Adjustment - electric masts only	27
2.1.5	Troubleshooting	28
3	Using Depth and Slope Guidance	29
3.1	Using Depth and Slope Mode	30
3.1.1	The work screen	30
3.1.2	Overlays	31
3.1.3	System settings	32
3.1.4	The Back icon	33
3.1.5	For more information	34

3.2	Bench Heading	34
3.2.1	One point method	34
3.2.2	Two point method	34
3.2.3	Troubleshooting	35
3.3	Bench Elevation	36
3.3.1	Bench with a relative elevation	36
3.3.2	Bench with a reference elevation (known elevation)	37
3.3.3	Placement of sections at the bench point	38
3.3.4	Useful text items	38
3.4	Slope and Section Memories	39
3.4.1	Mainfall memories	39
3.4.2	Cross slope memories	40
3.4.3	Section memories	41
4	Using Cross Slope Guidance	46
4.1	Using Cross Slope Mode	47
4.1.1	Selecting Cross Slope guidance	47
4.1.2	Target cross slope	47
4.1.3	Overlays	48
4.1.4	Autos	48
4.1.5	Text items	48
4.1.6	System settings	49
4.1.7	The shortcut bar	49
4.1.8	The Back icon	50
4.1.9	Work settings	50
5	Using Design Guidance	51
5.1	Using Design Mode	52
5.1.1	Selecting Design mode	52
5.1.2	The work screen	52
5.1.3	Overlays	53
5.1.4	System settings	54
5.1.5	The Back icon	55
5.1.6	For more information	55
5.2	Using Elevation Offsets	56
5.2.1	Accessing the Elevation Offset screen	56
5.2.2	The Elevation Offset screen	57
5.2.3	Applying an elevation offset	57
5.2.4	Creating, editing or deleting memories	58
5.3	Horizontal Guidance	58
5.3.1	Access the Horizontal Guidance screen	58
5.3.2	The Horizontal Guidance screen	59
5.3.3	Horizontal position information	62
5.3.4	Creating, editing or deleting memories	62
5.4	Vertical Guidance	62
5.4.1	Access the Blade Manager screen	63
5.4.2	The Blade Manager screen	63

5.4.3	Overcut Protection	65
5.4.4	Edit the cutting edge length	65
5.4.5	Troubleshooting	65
5.5	Working with Points	66
5.5.1	Displaying points	66
5.5.2	Filtering points	66
5.5.3	Deleting a point	66
5.5.4	Recording a point	67
5.5.5	How to record a point	68
5.5.6	Point files	68
5.5.7	Navigating to a point	69
5.5.8	Troubleshooting	69
5.6	Measured Data	69
5.6.1	Creating a Measured Data	69
5.6.2	Deleting a Measured Data	70
5.6.3	Changing the Measured Data of a point	70
5.7	3D Line Guidance	70
5.7.1	Loading a 3D lines file	71
5.7.2	Accessing the 3D Line Guidance screen	72
5.7.3	Selecting a 3D line for guidance	72
5.7.4	Changing 3D line guidance	72
5.7.5	Lightbar guidance to a 3D line	72
5.7.6	Useful text items	73
5.8	Lane Guidance	73
5.8.1	Holding your blade onto a surface or lane	73
5.8.2	Extending a lane sideways	73
5.8.3	The shortcut key	74
5.8.4	The Lane Guidance screen	75
5.8.5	Lane Guidance limits	76
5.8.6	Troubleshooting	76
5.9	Using GNSS	76
5.9.1	Troubleshooting	76
6	Using Infield Guidance	79
6.1	Infield Designs	80
6.1.1	Level pad design	80
6.1.2	Slope design	80
6.1.3	Alignment & Section design	81
7	Using Single-3D Guidance	91
7.1	Using UTS for Guidance	92
7.1.1	The UTS Settings screen	92
7.1.2	The UTS Management screen	92
7.1.3	Troubleshooting UTS guidance	97
7.2	Best Practices When Using Single-3D Guidance	98
7.2.1	UTS	99
7.2.2	General procedures before a grading run	99

8	Using Autos	100
8.1	Autos Setup - all machines	101
8.1.1	Autos status indicators	101
8.1.2	Engaging Autos - D3 - D5 and Trimble Valve Module machines	102
8.1.3	Engaging Autos - D6 - D7 machines	104
8.1.4	Troubleshooting	106
8.2	Autos Optimization	106
8.2.1	Presets	106
8.2.2	Optimize the Autos performance	108
8.3	Best Practices when Using Autos	110
8.3.1	Prepare the machine	111
8.3.2	Best practices for operating dozers	111
9	Mapping	118
9.1	Mapping	119
9.1.1	Using mapping	119
9.1.2	Start mapping with an empty map	120
9.1.3	Start mapping with a pre-mapped surface	120
9.1.4	Downloading ground surface data from an online source	121
9.1.5	Deleting map data	122
9.1.6	Inspecting a map	122
9.1.7	The work screen	122
9.1.8	For more information	124
9.1.9	Troubleshooting	124
10	Avoidance Zones	125
10.1	Avoidance Zones	126
10.1.1	Avoidance zone icons	126
10.1.2	The work screen	127
10.1.3	Machine boundary	127
10.1.4	Troubleshooting	127
A	Remote Switch and Joystick Configuration on other machine models	128
A.1	Remote Switch Configuration for machines with a Trimble Valve Module	129
A.2	Remote Switch Configuration for machines with steering control	129
A.2.1	Vertical offset remote switch	129
A.2.2	Horizontal offset remote switch	130
A.3	Joystick Configuration for Cat D3-D4 machines	131
A.4	Joystick and Remote Switch Configuration for Komatsu machines	131
A.4.1	Joystick	131
A.4.2	Remote Switch	132
B	Legal and Regulatory	133
B.1	END USER LICENSE AGREEMENT	134
B.2	Copyright Information	140
B.3	Compliance notices	140

B.3.1	US FCC regulations	140
B.3.2	Canadian license-exempt RSS standards	141
B.3.3	European Union CE compliance	142
B.3.4	European Union recycling compliance	142
B.3.5	Australian and New Zealand AS/NZS 55022 compliance	142
B.3.6	Japan Radio Type Approval	143
B.3.7	RoHS Statement	143
B.3.8	Taiwan	143
B.4	Safety information	143
B.4.1	Laser Safety	144
B.4.2	Magnet Safety	145
B.4.3	Crushing prevention and cutting prevention	145
B.4.4	Operation	145
B.4.5	Exposure to radio frequency (RF) signals	147
B.4.6	Telecommunications & Internet Association (TIA) information	148
B.4.7	Warnings	148
	Notices	151

Controls and Guidance

In this chapter:

- ▶ Viewing Licenses
- ▶ Joystick Configuration for Cat D5–D7 machines
- ▶ On-screen Lightbars
- ▶ External Lightbars
- ▶ Transferring Files
- ▶ Network

You need to set up and control the guidance system and understand the guidance information the system provides. This chapter describes, in general terms, how these components are used.

1.1 Viewing Licenses

To view the Licenses screen:

- From the Dashboard, tap the Licenses tile.
- From the System Settings menu, select Licenses.

Your technician can install licenses manually on your system, or sync them with the cloud. If the installed license is from the cloud, a cloud icon  displays.

1.1.1 License types





Licenses enable different levels of functionality within the system. The following types of licenses are available:

License Type	Description
Core license	Allows the system to operate and provide basic machine guidance.
Software maintenance license	Bundled together with the core license to allow users to install upgrades during the period of validity.
Module license	Optional licenses that build on the core license to provide additional functionality. For example, Infield Designs, 3D Design Guidance.
Advanced module license	Optional licenses that build on the core license to provide advanced functionality. For example, Earthmoving, workflow optimization.
GNSS receiver license	Required together with some module licenses if GNSS receivers are used for the guidance solution. The license name depicts the type of corrections received. For example, Left GNSS Receiver with Full RTK Precision.
GNSS constellation license	Optional GNSS receiver licenses you can enable to receive signals from the following GNSS constellations: <ul style="list-style-type: none"> • Global Positioning Satellite System (GLONASS) satellites, operated by the Russian Department of Defense. • Galileo Satellite System, operated by the European Space Agency. • BeiDou Navigation Satellite System (BDS) satellites, operated by the Chinese National Space Administration.

License Type	Description
	<i>Note – By default, all GNSS receivers can receive signals from the Global Positioning System (GPS) satellites, operated by the United States Department of Defense and Quasi-Zenith Satellite System (QZSS) satellites, operated by the Japanese Satellite Positioning.</i>

1.1.2 Status icons

The system provides a status icon beside each license, as shown below:

Icon	Type	Description
	Good	For the current configuration, the license is installed correctly.
	Attention	<ul style="list-style-type: none"> For the current configuration, a license that is expected, and which adds functionality, is missing or expired. The installed license is about to expire.
	Warning	For the current configuration, a license that is required is missing or expired.
	None	A device is connected, but has no license installed.

1.1.3 License information

Tap on an installed license for more information. An information panel displays the following details:

License Attributes	Description
Functionality	Description of the functionality that the license provides.
Status	Whether the license is installed or not installed.
Type	<ul style="list-style-type: none"> Perpetual – an open-ended license. Subscription – license that expires after a fixed term, if not renewed.
Location	<ul style="list-style-type: none"> Installed on the system ECM. Installed on the display. Installed on the left/right GNSS receiver.
Expiration (if subscription)	<p>The date the license will expire.</p> <p><i>Note – Your technician can manage licenses via the Web Interface.</i></p>

1.2 Joystick Configuration for Cat D5–D7 machines

Note – For all other joysticks, see Appendix A, Remote Switch and Joystick Configuration on other machine models.

You can use certain switches on the right joystick to perform common tasks while keeping your hands close to the machine controls. The joystick switches only function when you are in the work screen.

The joystick switches let you:

- Engage Autos.
Each press of the auto switch will cycle between Auto and Manual.
- Increase or decrease the elevation offset.
Press and hold the mode switch while you press the increment/decrement elevation offset switch.

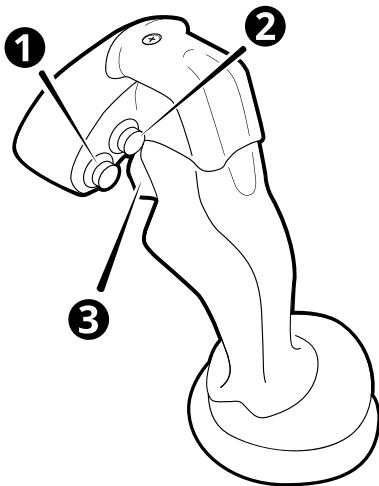

- | | |
|---|--|
| <p>❶</p> <ul style="list-style-type: none"> • Auto switch. • Decrement elevation offset switch. | <p>❷</p> <p>Increment elevation offset switch.</p> |
|---|--|
-
- ❸ Mode switch - enables the increment/decrement switches.

1.3 On-screen Lightbars

Note – These instructions apply to both blade slope and cross slope systems. Use these instructions for either system configuration:

- *Blade slope systems measure - blade slope only*
- *Cross slope systems measure - blade slope, blade rotation and machine mainfall*

Lightbars provide you with guidance information. They enable you to view the guidance information, blade, and the surface you are working at the same time.



TIP – Lightbars provide guidance to designs or alignments, they do not provide guidance to a point.

1.3.1 The Lightbars screen

Use the Lightbars screen to select the guidance that you want. You can access the Lightbars screen from the System Settings menu .





The screen shows the current lightbar configuration.

There are also options for the left, center and right lightbars. Use the toggle to turn the lightbars on and off.

1.3.2 Understanding lightbar information

The on-screen lightbars appear along the left, top, and right edges of the display, depending on your system configuration.

The following table describes the different items in the left/right on-screen lightbars:

Item		Function
Live location arrow		The arrow moves along the lightbar, tracking changes in the position of the cutting edge. It shows whether the current position is cut, fill or on grade in relation to the design or target surface.
Cut		The cut zone is red, and is above the on grade tolerance zone. The cut zone is active when the current position of the cutting edge is above the design or target surface.
On grade tolerance	 or 	The on grade tolerance zone is always bright green. Note – To change the on-grade tolerance zone, go to <i>System Settings > Grade Tolerance</i> .
Fill		The fill zone is blue, and is below the on grade tolerance zone. The fill zone is active when the current position of

Item	Function
	the cutting edge is below the design or target surface.

The lightbars behave differently depending on the mode you are working in.

The following tables describe what the lightbars display for each mode.

2D sensor combinations and Depth and Slope mode

Left lightbar

Cut/Fill guidance from the left tip:

- Red – Cut
- Green – On grade
- Blue – Fill

Center lightbar

No guidance given

Right lightbar

Cut/Fill from the right tip:

- Red – Cut
- Green – On grade
- Blue – Fill

Design mode

Left lightbar

Cut/Fill guidance for the left tip:

- Red – Cut
- Green – On grade
- Blue – Fill

Center lightbar

The distance and direction (left or right) from the tip to a selected line:

- Green – the cutting edge focus is on the line.
- Amber – the cutting edge focus is not on the line.

Right lightbar

Cut/Fill guidance for the right tip:

- Red – Cut
- Green – On grade
- Blue – Fill

1.3.3 Useful text items

- Cut/Fill Left
- Cut/Fill Center
- Cut/Fill Right
- Offline

Note – If the text item value is Cut then the icon in the text item shows a red arrow; if it is Fill it shows a blue arrow; and if it is within the on grade tolerance it shows a green arrow.

1.3.4 System buzzer

When the lightbars are in Cut/Fill Left and Cut/Fill Right, the system buzzer Cut/Fill is determined on the blade tip that is farthest from design. Both tips need to be within grade tolerance for the buzzer to sound.

1.3.5 Troubleshooting

The lightbars are disabled if there is no guidance available, for example if the elevation is not benched. When the lightbars are disabled, they appear as follows:

- The location arrow does not appear
- The lightbars are grayed-out
- The Cut/Fill or Offline text items do not show any values

Note – These instructions apply to both blade slope and cross slope systems. Use these instructions for either system configuration:

- Blade slope systems measure - blade slope only
- Cross slope systems measure - blade slope, blade rotation and machine mainfall

1.4 External Lightbars

Lightbars provide you with guidance information. Properly installed external lightbars enable you to view guidance information, the blade, and the surface you are working, at the same time.



TIP – Lightbars provide guidance to designs or alignments, they do not provide guidance to a point.

1.4.1 The Lightbars screen

Use the Lightbars screen to select the guidance that you want. You can access the Lightbars screen from the System Settings menu .

The screen shows the current lightbar configuration.

There are also options for the left, center and right lightbars. Use the toggle to turn the lightbars on and off.

To adjust the brightness of the lightbars, use the slider at the bottom of the screen.

1.4.2 External lightbar behavior

You can install up to three lightbars on your machine. The lightbars behave differently depending on what mode you are working in.

The following tables describe what the lightbars display for each mode.

Note – To change the on-grade tolerance zone, go to System Settings > Grade Tolerance.

2D sensor combinations and Depth and slope mode

Left lightbar

Cut/Fill guidance for the left blade tip:

Green – On grade

Amber – Not on grade

Center lightbar

No guidance given

Right lightbar

Cut/Fill guidance for the right blade tip:

Green – On grade

Amber – Not on grade

Design mode

Left lightbar

Cut/Fill guidance for the left blade tip:

Green – On grade

Amber – Not on grade

Center lightbar

The distance and direction (left or right) from the blade tip to a selected line.

Green – the blade focus is on the line

Amber – the blade focus is not on the line

Right lightbar

Cut/Fill guidance for the right blade tip:

Green – On grade

Amber – Not on grade

1.4.3 Useful text items

- Cut/Fill Left
- Cut/Fill Center
- Cut/Fill Right
- Offline

Note – If the text item value is Cut then the icon in the text item shows a red arrow; if it is Fill it shows a blue arrow; and if it is within the on grade tolerance it shows a green arrow.

1.4.4 System buzzer

When the lightbars are in Cut/Fill Left and Cut/Fill Right, the system buzzer Cut/Fill is determined on the blade tip that is farthest from design. Both tips need to be within grade tolerance for the buzzer to sound.

1.4.5 Troubleshooting

The lightbars are disabled if there is no guidance available, for example if the elevation is not benched. When the lightbars are disabled, they appear as follows:

- The location arrow does not appear
- The lightbars are grayed-out
- The Cut/Fill or Offline text items do not show any values

If you notice either of the following problems, ask your technician to check the configuration of the external lightbars in the Web Interface:

- A lightbar pattern is inverted.
- The lightbars are lit in the wrong order, for example the right lightbar is showing the left side Cut/Fills.

1.5 Transferring Files

The File Transfer screen is available in the System Settings menu . It lets you do the following:

- Import files to the machine from the display's hard drive, or, an external storage device.
- Export files from the machine to the display's hard drive, or, an external storage device.
- Custom select, if enabled, the files you want to import from the display's hard drive, or, an external storage device.

If you have an Operator Plus account you can perform further file management functions via the Advanced button on either the File Transfer screen or the Project screen.

Note – To transfer files via a USB flash drive, you must have a TD520 display and a FAT32 format USB flash drive. Any USB flash drive larger than 32GB may require a third-party application to format it as FAT32.

1.5.1 File categories

Each time you import or export files to or from the machine, you need to choose the files that you want to transfer. To do this, select the checkbox next to the category.

- Earthworks Data: You can transfer all data files or none.
- Projects: You can transfer the project files of your choice. Expand the Projects file to show each project with its own checkbox.



TIP – Within the expanded project, select Infield Data to only export the infield designs for the project.

- Production Data: You can transfer data files for use in VisionLink, WorksOS or both.

1.5.2 File structure for external storage devices

When using Import Files TO Machine files on external storage devices, the files must be saved within the folder structure below:

Path	Description of Contents
<Root>:\ProjectLibrary	Top-level folder containing the data sub-folders.
<Root>:\ProjectLibrary\ EarthworksData	Top-level folder for data files.
<Root>:\ProjectLibrary\GeoData	Geographical data which is used in one or more projects.
<Root>:\ProjectLibrary\Projects	Project folders containing project-specific data such as designs.

Note – Place files only within the sub-folders of the top-level folders.

Note – Custom File Import TO Machine does not require the above folder structure on the external storage device.

1.5.3 Syncing files with the Connected Community

Transfer files between the machine and Connected Community to ensure the machine has the latest files and that the office has access to the data recorded on the machine.

If your machine is configured for syncing, an option to Sync Files with Connected Community Sync appears in the File Transfer screen. All relevant files within the current project are synchronized.

Automatic file sync

When automatic file sync is enabled in the Web Interface, files will automatically synchronize to Connected Community every 15 minutes, whenever the machine is powered and has an active internet connection. You are not told when the sync is in progress, or if it was successful or not.

Manual file sync

You can initiate a manual file sync to Connected Community at the end of the day; for example, if automatic file sync is not enabled or to ensure that all of the files from the last 15 minutes have been synced and are available in the office.

1. Access the File Transfer screen.
2. Confirm Sync Files with Connected Community is selected in Transfer Type.

3. Tap Sync. The File Transfer screen grays-out and a progress meter displays. Once the system connects with Connected Community, the progress meter indicates the file categories that are transferring.

To stop the sync, tap Cancel. The file transfer stops and any partial transfers (categories that did not completely transfer) are deleted. Any categories that did completely transfer are kept.

When the file transfer is complete a success notification appears.

If you initiate a sync with Connected Community and an automatic file sync is already in progress you are asked if you would like to continue. If you choose:

- Yes, the sync that is currently in progress stops and the sync that you initiated starts.
- No, the automatic sync that is currently in progress continues and the Transfer Files screen reappears.

1.5.4 Transferring files via an external storage device

Note – The TD520 display only supports USB flash drives that are FAT32 format. Any USB flash drive larger than 32GB may require a third-party application to format it as FAT32.

Import Files TO Machine

Before you can use the Import Files TO Machine option, you must create a folder structure on your external storage device that matches the machine's file organization structure. This enables the machine to place your files in the correct location during the transfer process.



TIP – Export the machine's existing folder structure to your external storage device to quickly create the necessary folder structure for transfers. For more information, see 1.5.6 Exporting files from the machine.

Preparing your external storage device for file transfer

1. Format your USB flash drive in the FAT32 format, if using a USB flash drive.
2. Create the top-level folder, or folders, required for the data to be transferred on your external storage device. For more information, see 1.5.2 File structure for external storage devices.
3. Copy your files to the appropriate folder on the external storage device (for example, copy your project files to *ProjectLibrary > Projects*).

Connecting your external storage device for file transfer

1. Log in to the display.
2. Connect your external storage device to the display. The File Transfer screen appears.
3. Import or export the files of your choice.



ATTENTION - When transferring files to or from an external storage device, an Android OS screen appears. The first time the screen appears, it is blank, apart from three vertical dots  in the upper right-hand corner. Select the dots and then select Show SD Card. The Android screen changes. From the left-hand panel, select your external storage device and then select SELECT in the lower right-hand corner. (Do not select any files or folders from the right-hand panel.)

1.5.5 Importing files to your machine

1. Access the File Transfer screen.
2. Select Import Files TO Machine from the *Transfer Type* field.
3. Select the source type from the *From* field.
4. Tap Next. The Import Files screen appears.
5. Select the files that you want to import.
6. Tap Import to start the file transfer. Tap Cancel to exit the screen without applying any changes.

The import process

After you tap Import a progress meter appears and the File Transfer screen is grayed-out.

First the system checks the available storage on the machine. Once sufficient space is confirmed the progress meter indicates the files that are transferring.

If you tap Cancel the file transfer stops.

When the file transfer is complete a success notification appears.

Files are overwritten with newest versions

When transferring files from an external storage device to the machine, all files on machine that have the same name as the files on the external storage device will be overwritten with the external storage device files. This includes the user preferences file `userdata.pref.xml`, which saves the settings; for example, the text items that are configured.

To keep the user preferences saved on a machine, either:

- Perform a File Transfer of the EarthworksData to the USB flash drive first, then perform a File Transfer from the USB flash drive to the machine

OR

- Untick the EarthworksData box when transferring files from the USB flash drive to the machine

Note – The `userdata.pref.xml` file is stored at `ProjectLibrary > EarthworksData > [Machine Name Folder]`

1.5.6 Exporting files from the machine

1. Access the File Transfer screen.
2. In the *Transfer Type* field, select Export Files FROM Machine.
3. In the *To* field, select the destination.
4. Tap Next. The Export Files screen appears.
5. The available files to export are listed. Select the files that you want to export.
6. To initiate the file transfer, tap Export; to exit the screen without applying any changes, tap Cancel.

The export process

After you tap Export a progress meter appears and the File Transfer screen is grayed-out.

The system checks the available storage on the destination device. Once sufficient space is confirmed the progress meter indicates the files that are transferring.

If you tap Cancel the file transfer stops.

When the file transfer is complete a success notification appears.

Note – *If a full backup of all files on the machine is required this can only be performed via the Web Interface “Back up all” option on the File Management page.*

1.5.7 Using custom file import

1. Access the File Transfer screen.
2. Select Custom File Import TO Machine from the *Transfer Type* field.
3. Select the project to import the files into, or add a new project, from the *Project* field.
4. Tap Next. If adding a new project, enter a project name in Project Name and tap Save.
5. Find the file or files you want to import on the file list screen.
 - a. Tap a single file to select it.
 - b. Tap and hold to select multiple files and tap Open in the upper right corner.
6. Confirm the files you want to import on the Import Files screen and tap Import.

1.5.8 Troubleshooting

The following notices may appear when you are transferring files:

Unsuccessful Connection

This message appears if the system cannot connect to the Connected Community. Tap OK to return to the File Transfer screen. Check the Connected Community settings and the Internet Connection Status in the Web Interface.

Insufficient Storage

This message appears if sufficient space is not available in the destination device. Tap OK to return to the File Transfer screen. From here you can choose a different destination device (if available) and then retry, or tap Cancel.

Failed File Export

This notice appears if for any other reason a file export fails (for example if the USB flash drive is disconnected during a transfer).

1.5.9 System operation in Android 11



There are differences in system behavior when you use a display with the Android 11 operating system:

- There is no longer an icon for the applications menu. To access the applications menu, touch and drag upwards from anywhere on the home screen.
- When you touch-and-hold on a file to copy it to a new location, drag the file over the new location and wait for a green + icon.
- Holding the file over a new drive will open the drive and show the sub-directories.
- If the directory that the system opens is higher than the root directory, tap the overflow icon in the upper left corner to access lower directory levels.
- When you navigate to a different location, select the folder and tap the Use This Folder button.
- If you change the display's orientation and tap the Android Overview/Recents button (the onscreen navigation button on the right), the apps will appear upside down. To avoid this, set the display in the correct orientation before using the system. If apps are upside down, close and re-open them with the display in the intended orientation.
- The first time that you transfer files from the machine to the display, the display will ask for *All files access* permission. Grant permission.
- Every time you transfer files from the machine to the display, when you select the target folder, the display will ask permission to access the folder. Grant permission.
- If you use FileFlipper to save converted files to a USB drive, the files are not written to the drive until after FileFlipper reports the process is complete. Either:
 - Wait 5 seconds after FileFlipper reports that the process is complete before you remove the USB drive.
 - Eject the USB stick safely: Swipe down to open the quick setting menu, tap the USB stick notification, and then tap the Eject button.

1.6 Network

Action bar icons





The Network icons that appear on the action bar show the high-level status of the associated network feature. The icons are:

	Connection Status (cell)	A warning (orange) shows if the connection is not yet established on start-up, or lost during operation.
	Connection Status (Wi-Fi)	
	Cloud Services	A warning (orange) shows if any of the underlying services fail to connect, or if cell/Wi-Fi connection is lost.

Tap an icon to open the Network screen.

Network screen

The connection icons on the Network screen show the 3 parts of the connection:

1. Gateway Device () – the hardware acting as the connection device on your system
 - Error state (red) – device not found
 - Warning state (orange) – the device is configuring or there is an issue with the device configuration
2. Connection – a cell () or Wi-Fi () icon, depending on the gateway configuration
 - Warning state (orange) – there is a missing or unconfigured device, or a problem with the connection to the internet
3. Cloud Services () – the parts of the cloud service
 - Only configured services show in the list
 - Warning state – the last attempt to connect or transfer data failed

Note – The warnings are sequential, so if there is a warning for the Gateway Device, there will also be a warning for Connection Status and Cloud Services.

Using 2D Positioning Sources

In this chapter:

- ▶ Using Lasers

This chapter introduces the use of 2D positioning sources.

Note – For Cross Slope guidance, see 4.1 Using Cross Slope Mode.

2.1 Using Lasers



WARNING — Do not stare into the laser beam when the laser transmitter is operating. For more information, refer to the documentation that came with your laser.

Note – Use a minimum 600 RPM laser strike speed.

Note – Ensure the Cutting Edge Length, accessed via the Edit button on the Blade Manager screen is accurate. Inaccurate Cutting Edge Length values that do not account for cutting edge wear can cause inconsistencies in machine guidance.

Note – These instructions apply to both blade slope and cross slope systems. Use these instructions for either system configuration:

- Blade slope systems measure - blade slope only
- Cross slope systems measure - blade slope, blade rotation and machine mainfall

2.1.1 Select sensor combination

To select a 2D sensor combination:

1. Connect the Laser Receiver to the system using the appropriate cables.
2. From the Dashboard, tap the Machine Setup tile.
3. From the Machine Setup screen, select 2D as the positioning source.
4. From the Sensor Combination field, tap the Open icon . The Sensor Combination screen appears.
5. The sensor combinations that are currently connected on your machine are listed. Select one of the laser combinations, for example, Laser + Laser and tap Apply.
6. You are returned to the Machine Setup screen. Tap Apply.
7. From the Dashboard, tap Start to enter the work screen.



TIP – For quick access to the Sensor Combination screen, touch and hold the sensor combination icon in the guidance bar, at the top of the work screen. Alternatively, a single tap on the icon on the guidance bar will cycle through the Quick Change list that is configured in the Sensor Combination screen. For less used combinations, use the re-order list icon  to drag them out of the Quick Change list and drop them into the Other Available combination list.

Set the target cross slope

If you use a single laser, you need to set the target blade or cross slope. To set the Target Slope, do one of the following:

- Touch and hold the Target Slope field in the guidance bar to access the Target Cross Slope screen.
- Select Target Cross Slope or Target Blade Slope from the Work Settings menu.
- Edit the Target Slope in the Bench Laser screen.

Use the Target Slope screen to apply a new target slope, or to select or edit an existing Target Slope memory.



TIP – To match the slope of a surface, place the blade on the surface and tap the Set Target Slope icon  .

2.1.2 Bench Laser Receiver

Note – A bench is retained over a power cycle, a change in positioning source, and a project change.

When using laser receivers for 2D guidance, set the target slope that is being constructed on the transmitting laser so that the laser plane is parallel to the surface to be built. The laser transmitter is set up to match the target grade and slope.

When using a single laser, always work parallel or perpendicular to the grade of the laser plane to ensure accurate guidance.

When you use a single laser receiver with cross slope, always work parallel to the grade of the laser plane.

Prepare to bench

To prepare to bench single or dual laser receivers:

1. On machines using a single laser, check that the target slope is entered correctly.
2. If required, adjust the blade so that it is in the working position.
3. On machines using a single laser, ensure the current cross slope or blade slope value matches the target cross slope.



TIP – Enable Autos and allow the cutting edge to drive to the target cross slope. Alternatively, manually drive the cutting edge to the target cross slope.

4. To bench, either:
 - Place the laser controlled blade tip in the working position, confirm the laser strikes the receiver and tap Bench. This sets Cut/Fill to 0.00 at that position and you can enter an offset above or below the benched height to get guidance to.
 - Use one of two toggles described in the following table:

Bench method	Description
Bench to receiver	Available when using a laser receiver on a non-electric

Bench method	Description
center	mast. A laser strike is not required to bench.
Bench with a Reference Elevation (known elevation)	<p>Available when using a laser receiver on any mast. A laser strike is required to bench. Use this option when working to target elevations and a known elevation is available.</p> <p>Place the laser controlled blade tip on the known elevation and tap Bench. This sets the Cut/Fill to 0.00 at that position. Then enter the target elevation.</p>

Bench to receiver center

1. Toggle Bench to Receiver Center on.
2. Use a tape measure to measure the height to the laser plane above grade. Adjust the measurement for any additional required cut or fill.
3. Use a tape measure to adjust the laser receiver on the mast so that the measurement from the laser receiver center to the cutting edge equals the measured height including any additional cut/fill in the previous step.
4. Tap Bench.

Bench with a relative elevation

1. Tap the Bench Laser icon  in the shortcut bar to bench directly or touch and hold the icon to open the Bench Laser screen. Alternatively, access the Bench Laser screen via the Work Settings menu.
2. Ensure the Reference Elevation toggle is off.
3. If using a single laser, adjust the blade so that the current cross slope matches the target cross slope.

Note – *If the target cross slope changes after benching, you need to re-bench.*

4. If required, toggle Clear Offset on Bench off to keep your previous elevation offset after benching. The system remembers your selection for future use.
5. If not using electric masts, move the laser receiver to ensure that the laser strike is within +/-85 mm (3.35 inches) from its center.
6. Position the blade as described above in Prepare to bench.
7. Raise or lower the blade so that the cutting edge is at the desired height for grade.
8. Tap Bench.

Bench with a Reference Elevation (known elevation)

1. Position the blade over the benchmark.
2. Tap the Bench Laser icon  in the shortcut bar to bench directly or touch and hold the icon to open the Bench Laser screen. Alternatively, access the Bench Laser screen via the Work Settings menu.
3. If using a single laser, adjust the blade so that the current cross slope matches the target cross slope.
Note – If the target cross slope changes after benching, you need to re-bench.
4. If required, toggle off Clear Offset on Bench to keep your previous elevation offset after benching. The system remembers your selection for future use.
5. If not using electric masts, move the laser receiver to ensure that the laser strike is within +/-85 mm (3.35 inches) from its center.
6. Toggle the Reference Elevation on and enter the elevation of the blade tip (from a benchmark).
7. Tap Bench.

Note – The reference elevation bench is stored as a locked offset in the memories list.

Reverse Search - electric masts only

During benching as the masts are being driven, you can tap Reverse Search at any time to drive the masts in the opposite direction. If you tap Cancel, the masts stop driving.

Return Masts to bench height - electric masts only

Tap Bench Return to return the masts to their benched height. This may be necessary when, for example, you change between sensor combinations.

2.1.3 Set an Elevation Offset

If required you can use an elevation offset. This enables you to grade surfaces that are achievable in a single pass, such as by managing the depth of a cut on each pass.

You can access the Elevation Offset screen from the Work Settings menu . Or, you can touch and hold the Elevation Offset icon in the guidance bar. Enter the desired offset from the benched elevation and tap Apply.

You can also increment or decrement the offset using the joystick buttons.

Note – Any offset applied must not result in the receivers falling out of the laser strike range.

2.1.4 Linked Elevation Adjustment - electric masts only

When using dual laser receivers on electric masts, the linked elevation offset may need to be adjusted if there are pass to pass mismatches (saw-tooth effect) after making one pass

and then moving over to make a second pass beside the previous pass

1. Check the blade wear before you try to adjust the linked elevation offset. If applicable, update the Cutting Edge Length accessed via the Edit button on the Blade Manager screen.
2. Make two parallel passes beside each other.
3. Measure the step size (saw tooth) between the passes.
4. If there is a step between passes, access the Linked Elevation Adjustment screen via the Work Settings menu.
5. Enter a positive value to lift the left side of the blade (from the operator's perspective) and lower the right side, or enter a negative value to lower the left side of the blade and lift the right side.

2.1.5 Troubleshooting

The LEDs at the top of the laser receiver indicates the status and position of the laser strike.

LED pattern	Meaning
Not illuminated	No power
Slow flash (0.4 seconds on, 1 second off)	No laser strike
Flash (0.2 seconds on, 0.2 seconds off)	Laser strike detected above center of the receiver
Fast flash (0.1 second on, 0.1 second off)	Laser strike detected below center of the receiver
On continuously	Laser strike detected at the center of the receiver

Using Depth and Slope Guidance

In this chapter:

- ▶ Using Depth and Slope Mode
- ▶ Bench Heading
- ▶ Bench Elevation
- ▶ Slope and Section Memories

To generate guidance information, the system measures the cutting edge's position relative to a physical reference surface. This is called Depth and Slope guidance.

Unlike Design guidance, depth and slope guidance does not rely on knowing the machine's three dimensional location.

Note – These instructions apply to both blade slope and cross slope systems. Use these instructions for either system configuration:

- *Blade slope systems measure - blade slope only*
- *Cross slope systems measure - blade slope, blade rotation and machine mainfall*

3.1 Using Depth and Slope Mode

Depth and Slope mode lets you use slopes, sections, and offsets as required, to define your target grade.

Note – These instructions apply to both blade slope and cross slope systems. Use these instructions for either system configuration:

- Blade slope systems measure - blade slope only
- Cross slope systems measure - blade slope, blade rotation and machine mainfall

To select Depth and Slope mode:

1. From the Dashboard, tap the Machine Setup tile and select the positioning source that you require.
Note – The positioning source you select will determine the modes that you can select from the Job Setup screen.
2. From the Dashboard, tap the Job Setup tile.
3. From the Job Setup screen select a project and set the *Mode* field to Depth and Slope.
4. The *Extra Linework (optional)* field displays if you have a 3D guidance solution. This helps you to reference an office design while on the work screen.
Note – Access to extra linework is enabled or disabled by your technician. 3D line designs are not available to select. Horizontal guidance to the extra linework is not available.
5. Select the appropriate linework from the *Extra Linework (optional)* field.
6. Tap Apply.
7. From the Dashboard, tap Start. The work screen appears.

3.1.1 The work screen

In Depth and Slope mode, this icon appears at the top left-hand side of the work screen:



Touch and hold the icon to open the Job Setup screen.

The Depth and Slope target icons

The target icons always appear in the same order left to right on the guidance bar, as shown below:

Mainfall	Cross Slope	Elevation Offset

Use the target icons in the following ways:

- Tap to cycle through the configured target memories.
- Touch and hold to access the respective target configuration screens.

The target settings screens

- Use the Target Mainfall and Target Cross Slope screens to select, edit or create a new slope.
- If you save a section, you can use it in either the mainfall or the cross slope orientation.
- Use the Elevation Offset screen to select, edit or create a new target offset.
- You can use the increment/decrement elevation offset switch to increase and decrease the offset.

Note – If you switch from Depth and Slope mode to Design mode, the system reverts back to Horizontal and Elevation Offsets of 0.00.

3.1.2 Overlays

The overlays icon is in the top right-hand corner of the guidance bar: 

Use this icon to directly access the Overlays screen, which controls what appears on the guidance view.

The guidance view

The guidance view displays the machine relative to the surface being worked. You can set up to three different views to display at once, from the following view types:



- 3D
 - Note – The 3D view only renders the design surface for a radius of 150 m (about 500 feet) from the current machine position.*
- Cross-section
- Profile
- Plan
- Cut/Fill Left
- Cut/Fill Right
- Cut/Fill Center

Text items

Use the text ribbon area (across the bottom of the guidance view) to display text items of your choice. By default, the system displays ribbon items appropriate for your machine. Useful text items for Depth and Slope mode are:

- Cut/Fill Left and Cut/Fill Right
- Body Slope
- Body Mainfall

Touch and hold any text item in the text ribbon to open the corresponding context menu:

- Tap Add  to select a new text item to add to the text ribbon.
- Tap Replace  to select another text item to replace the current one.
- Tap Remove  to remove the current text item from the text ribbon.

At the bottom of the context menu, you can tap Go to Text Ribbon . Alternatively you can access it from the System Settings menu . The Text Ribbon screen allows you to:

- Drag-and-drop items to reorder your list. Alternatively, you can drag a text item in the text ribbon to shuffle it.
- Tap Edit to select which items appear.
- Tap Default to reload the default ribbon items for your machine.
- Enable or disable the display of the text ribbon in the work screen.

3.1.3 System settings

The System Settings icon is on the work screen: 

Use System Settings to access and configure various functions, including (but not limited to):

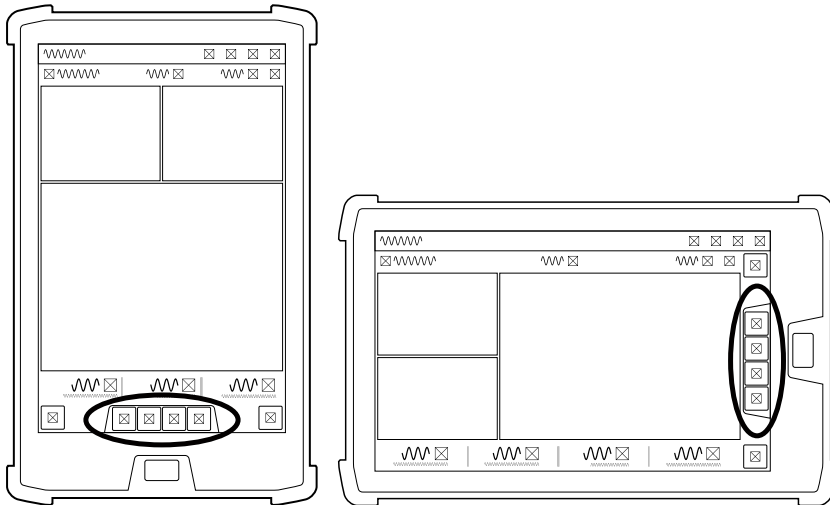

- Lightbars
- Units
- File Transfer
- Increments (where the inc/dec switches step size can be set)

The shortcut bar



The shortcut bar enables you to easily perform frequently repeated tasks. The shortcut icons are for Depth and Slope relevant items such as Blade Focus.

If a shortcut icon is blue, then you must configure that function before the system provides guidance for your machine. This includes:

- Bench Heading  which sets the direction of the design slope (mainfall).
- Bench Elevation which you can use to set a relative  or absolute  reference elevation.

Tap the blue icon to bench your machine or touch and hold the icon to open the relevant settings screen and then edit as required.

3.1.4 The Back icon

The Back icon is in the top left-hand side of the title bar: 

You can tap the icon or title to return to the previous screen; either the Dashboard or work screen.

Work settings

The Work Settings icon is in the lower right-hand side of the work screen: 

Use the Work Settings menu to access and configure those settings that change according to the requirements of each individual task, including (but not limited to):

- Target Mainfall
- Target Cross Slope
- Blade

3.1.5 For more information

See these following chapters:

- 3.2 Bench Heading
- 3.3 Bench Elevation

3.2 Bench Heading

Note – These instructions apply to both blade slope and cross slope systems. Use these instructions for either system configuration:

- *Blade slope systems measure - blade slope only*
- *Cross slope systems measure - blade slope, blade rotation and machine mainfall*

You must bench the heading before you begin working. Benching the heading sets the direction of the target mainfall. The system calculates target cross slopes perpendicular to the benched direction. You can use the current direction of the machine to bench, or choose two points on the ground.



TIP – Using the Two Point Method is more accurate as it defines the direction of the bench heading.

3.2.1 One point method

You can access the Bench Heading screen via the Work Settings menu or the shortcut bar.

Note – If you tap the Bench Heading icon  it will bench the heading directly. However, if you touch and hold it, you will open the Bench Heading screen.

1. Position the machine in the direction of the design mainfall.
2. Tap the Bench Heading icon  in the shortcut bar to bench the heading directly. This clears the current bench and sets a new bench heading in the direction of the blade focus.

Alternatively:

1. Touch and hold the Bench Heading icon  in the shortcut bar to open the Bench Heading screen.
2. Tap Bench.

3.2.2 Two point method

Use the two point method to bench the heading as this method is more accurate than the one point method.

You can access the Bench Heading screen via the Work Settings menu or the shortcut bar.

1. Position the machine in the direction of the design mainfall.
2. Touch and hold the Bench Heading icon  in the shortcut bar to open the Bench Heading screen.
3. Toggle the Two-Point Method on.
4. Follow the wizard to select two points:
 - a. Touch the attachment focus point on two points that are not too close together (there should be at least one meter between the two points). The mainfall runs parallel to the line between the two points and the cross slope is perpendicular to it.

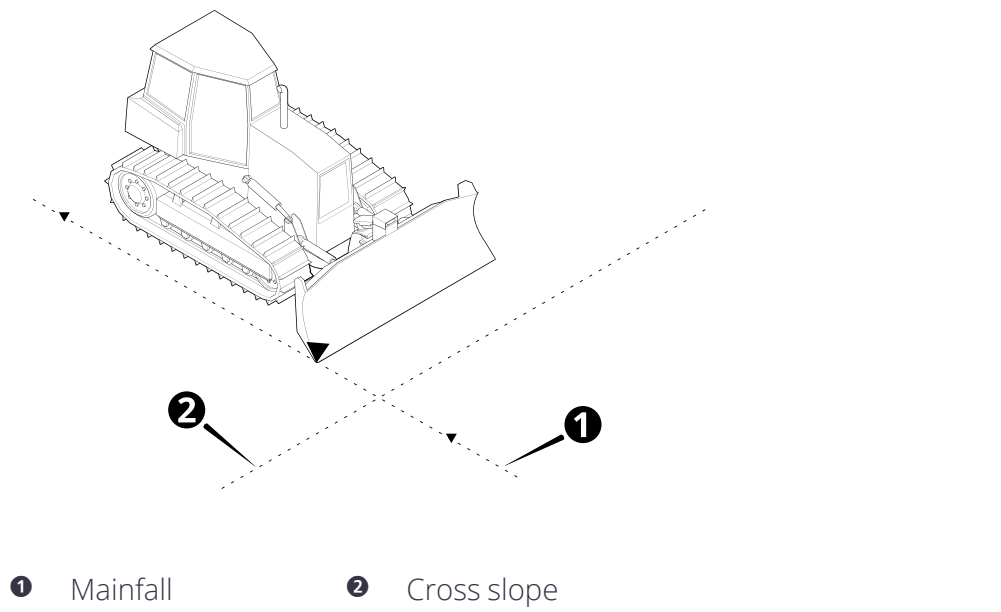

5. Tap Bench.

3.2.3 Troubleshooting

The table below lists some of the error messages that may appear when you use the two point method to bench the heading.

Error Message	Action
Point 2 not saved, bench points are too close	Select a second point that is further away from point one. There should be at least one meter between the two points.
Bench failed. Machine is moving.	Make sure the machine is completely stationary before you select a point.

Note – These instructions apply to both blade slope and cross slope systems. Use these instructions for either system configuration:

- *Blade slope systems measure - blade slope only*
- *Cross slope systems measure - blade slope, blade rotation and machine mainfall*

3.3 Bench Elevation

Until you bench, no guidance information is available, and the **Bench Elevation** message appears.

To bench, use either of the methods described in the following table:

Bench method	Description
Bench with a relative elevation	Place your blade focus on any point. This sets Cut/Fill to 0.00 at that position and you can enter an offset above or below the benched height to get guidance to.
Bench with a reference elevation (known elevation)	Place your blade focus on a benchmark with a known elevation. This sets Cut/Fill to 0.00 at that position and you can then enter a known elevation to get guidance to (instead of an offset away from the benched position).

Note – You need to bench the heading before you can bench the elevation.

3.3.1 Bench with a relative elevation

Using the Bench Elevation screen

You can access the Bench Elevation screen via the Work Settings menu or the shortcut bar.

Once you have positioned your machine, in the work screen:

Tap the Bench Elevation icon  in the shortcut bar to bench the blade focus directly. This sets Cut/Fill to 0.00 and you can enter an offset above or below the benched height to get guidance to.

Alternatively:

1. Touch and hold the Bench Elevation icon  in the shortcut bar to open the Bench Elevation screen.
2. Select the Guidance Focus.
3. Tap Bench.

Select a bench point

The bench point can be any arbitrary point, it does not even have to be a physical object.

If you use a physical object as the bench point, use something that is solid and will not move when you touch it with the blade.

Position the machine

Place the machine so that it is within reach of the bench point and the surface to work.

If using a section, orient the machine perpendicular to the mainfall of the section.

If using a slope, orient the machine parallel to the mainfall of the slope.

Position the blade

Position the blade focus on your bench point.

3.3.2 Bench with a reference elevation (known elevation)

Using the Bench Elevation screen

You can access the Bench Elevation screen via the Work Settings menu or the shortcut bar.

Once you have positioned your machine and blade, in the work screen:

1. Touch and hold the Bench Elevation icon  in the shortcut bar to open the Bench Elevation screen.
2. Select the Guidance Focus.
3. Toggle Clear Offset on Bench off to keep your previous elevation offset after benching. The system remembers your selection for future use.
4. Toggle the Reference Elevation on and enter the value.
5. Tap Bench.

This sets Cut/Fill to 0.00 at that position and you can then enter a known elevation to get guidance to.

To use the previous reference elevation value to re-bench the blade focus, tap the Bench Elevation Reference icon  in the shortcut bar.

Select a benchmark

The benchmark is a known or absolute point in the system. Select a benchmark with a known elevation e.g. get a surveyor to measure the elevation of the benchmark.

If possible, the benchmark should be something solid that will not move when you touch it with the blade.

Position the machine

Place the machine so that is within reach of the benchmark and the surface to work.

If using a section, orient the machine perpendicular to the mainfall of the section.

If using a slope, orient the machine parallel to the mainfall of the slope.

Position the blade

Position the blade focus so that it is touching your benchmark.

If your benchmark is a survey peg or something that could move when touched, position the blade on the ground, as close to the peg as possible.

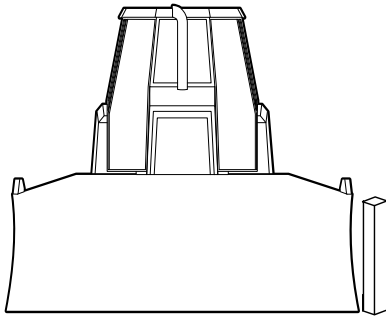

Alternatively:

1. Position the blade focus above your benchmark.
2. Measure the height from the benchmark to the blade focus.
3. Add the measured height to the height of the benchmark.
4. Use this measurement as the Reference Elevation.

3.3.3 Placement of sections at the bench point

If you have created a section on the target mainfall or target cross slope, the system locates the placement point of the section at the benching point.

3.3.4 Useful text items

Text items display information on the work screen. When you bench the elevation the following text items can be helpful:

- Cut/Fill <Center/Left/Right>
- Distance from bench
- Height from bench

3.4 Slope and Section Memories

Note – These instructions apply to both blade slope and cross slope systems. Use these instructions for either system configuration:

- *Blade slope systems measure - blade slope only*
- *Cross slope systems measure - blade slope, blade rotation and machine mainfall*

You can store cross slope or mainfall values in cross slope or mainfall slope memories respectively. These memories are only accessible when you use Depth and Slope mode. You can also store section memories.

You can access slope and section memories via the Memories button on the Target Mainfall and Target Cross Slope screens. You can save a slope or section memory as you perform certain tasks.

3.4.1 Mainfall memories

Select and apply a memory

You can select and apply mainfall memories via the Target Mainfall screen. There is always at least one memory stored.

Select the memory you require and tap Apply.

Save a slope memory

You can save a slope memory via the Save button on the Target Mainfall screen. When you save a slope memory, the system automatically assigns it the next available name, for example: Mainfall 2. If you want to edit the name, see [Edit or rename a slope memory](#).



Create a new slope memory

To create a new slope memory:

1. In the Target Mainfall screen, tap the Memories icon  on the right-hand side of the *Memory* field. The Mainfall Memories screen opens.
2. Tap Create. The Create Mainfall Memory screen opens. The system automatically assigns the next available name to the memory, for example: Mainfall 2.
3. If required, tap inside the *Name* field and edit the name.
4. Either use the arrows to increment or decrement the mainfall value, or tap inside the field to enter the value directly.
5. Tap Save. The Mainfall Memories screen appears and the memory has focus.

Edit or rename a slope memory

To edit a slope memory:

1. In the Target Mainfall screen, tap the Memories icon  on the right-hand side of the *Memory* field. The Mainfall Memories screen opens.
2. Select a Mainfall memory and tap the overflow icon  on the right-hand side of the memory. Select Edit. The Edit Mainfall Memory screen opens.
3. If required, tap inside the *Name* field and edit the name.
4. If required, edit the value of the mainfall.
5. Tap Save. The Mainfall Memories screen appears and the memory you edited has focus.

3.4.2 Cross slope memories

Select and apply a slope memory

You can select and apply cross slope memories via the Target Cross Slope screen. There is always at least one memory stored.

Select the memory you require and tap Apply.

Save a slope memory

You can save a memory via the Save button on the Target Cross Slope screen. When you save a slope memory, the system automatically assigns it the next available name, for example: Cross slope 2. If you want to edit the name, see Edit or rename a slope memory.



Create a new slope memory

To create a new slope memory:

1. In the Target Cross Slope screen, tap the Memories icon  on the right-hand side of the *Memory* field. The Cross Slope Memories screen opens.
2. Tap Create. The Create Cross Slope Memory screen opens. The system automatically assigns the next available name to the memory, for example: Cross Slope 2.
3. If required, tap inside the *Name* field and edit the name.
4. Either use the arrows to increment or decrement the mainfall value, or tap inside the field to enter the value directly.
5. Tap Save. The Cross Slope Memories screen appears and the memory has focus.

Edit or rename a slope memory

To edit a slope memory:

1. In the Target Cross Slope screen, tap the Memories icon  on the right-hand side of the *Memory* field. The Cross Slope Memories screen opens.
2. Select a cross slope memory and tap the overflow icon  on the right-hand side of the memory. Select Edit. The Edit Cross Slope Memory screen opens.
3. If required, tap inside the *Name* field and edit the name.
4. If required, edit the value of the mainfall.
5. Tap Save. The Cross Slope Memories screen appears and the memory you edited has focus.

3.4.3 Section memories



Sections are templates that let you build roads, banks and channels. A section can be made up of any number of reach and elevation points.

Each section has a placement point . The placement point configures how the section profile is applied relative to the current blade focus. When you bench, the placement point of the section is the benching point. The section is applied perpendicular to the direction of the machine heading.

Select and apply a section memory

You can select and apply section memories via the Target Cross Slope or Target Mainfall screen. Select Section from the Type drop-down list.



There is always at least one memory stored. Select the memory you require and tap Apply.

To edit the placement point of the section, tap the Previous Point  and Next Point  icons.

Create a new section memory

If you want to create a new memory:



1. In the Target Cross Slope or Target Mainfall screen, select Section from the Type drop-down list.
2. Tap the Memories icon  on the right-hand side of the *Memory* field. The Section Memories screen opens.
3. Tap Create.
4. To create a new memory, use one of the methods described in the following table.

Icon	Description
	On-screen mode. Use your finger directly on the screen to define section points.
	Focus mode. Use the machine blade focus to define section points.
	Templates mode. Use an existing section memory as a template. You can edit it and save it as a new section memory.

Drawing modes





The different drawing modes described in the table below are common to each of the section creation modes.

By default, the edit line drawing mode  is selected. Tap to select the drawing mode you prefer.

Icon	Mode and description
	Edit Point. In edit point mode you use coordinates to specify a points position (like rise over run).
	Edit Line. In edit line mode you use an angle and a slope distance from the previous point to specify a points position.
	Scale All. In scale all mode you use a width and a height to specify the sections size.

Common drawing tools

The icons on the bottom of the drawing screen provide useful tools to assist with the drawing of the section. The following icons are common to all section creation modes.

Icon	Description
	Tap to undo the last action.
	Tap to mirror the existing points. You can select between mirror from the end point or mirror from the origin point.
	Tap to view all the points in the section.
	<p>Lock to grid. When lock to grid is active new points are placed on the nearest intersection of the drawing grid.</p> <p>When don't lock to grid is active new points are placed anywhere in the drawing window. Tap to switch between the modes.</p> <p>Note – Lock to grid does not work with focus mode. The point will always be placed at the precise location of the blade focus.</p>

On-screen mode

You can draw points directly on the screen with your finger to create a new section memory.

Before you start, select the drawing mode that you prefer, as explained in Drawing modes.

Tap inside any of the fields to directly edit it. For example, the system automatically assigns the next available name to the memory, such as, Section 2. Tap inside the field to bring up the on-screen keyboard and rename it.

The cursor  identifies the active point on the section. The starting point of a section is always zeroed and any additional points that you add are relative to the start point.

Every time you lift your finger from the screen or pause for a couple of seconds with your finger still on the screen, a new point is added to the section.

Tap  to delete a selected point or double tap individual points to delete them.

Note – You cannot delete the starting point.

The icons on the bottom of the drawing screen provide useful tools to assist with the drawing of the section. See Common drawing tools

Tap Save when you are finished.

Focus mode

You can use the blade focus to create a new section memory.

Before you start, select the drawing mode that you prefer, as explained in Drawing modes.

Tap inside any of the fields to directly edit it. For example, the system automatically assigns the next available name to the memory, such as, Section 2. Tap inside the field to bring up the on-screen keyboard and rename it.

The cursor  identifies the active point on the section. The starting point of a section is always zeroed and any additional points that you add with the blade focus are relative to the start point.

Before you start, make sure that you select the correct blade focus. Tap the Focus icon  to select an alternative focus point.

Every time you move the machine blade to the next point in the section, tap the Add Point icon .

After you use the blade focus to create a point, you can use your finger on the screen to edit it. Tap on the point you want to edit. You can either edit the numeric fields directly or you can touch and hold the point with your finger on the screen and then drag and drop it to its new position.



TIPS:

- Touch and hold the point you want to edit until its color changes to yellow before you try to drag and drop it to its new position.
 - Zoom in to place your points more accurately. The resolution of the grid will get finer as you zoom in.
-

Note – The lock to grid setting  will affect the positioning of the point when dragging and dropping.

The icons on the bottom of the drawing screen provide useful tools to assist with the drawing of the section. See Common drawing tools.

Tap Save when you are finished.

Templates mode

You can use an existing section memory as a template. You can then edit and save it as a new section memory.

Select the section that you want to use as a template.

Select the drawing mode that you prefer, as explained in Drawing modes.

Tap inside any of the fields to directly edit it. For example, the system automatically assigns the next available name to the memory, such as, Section 2. Tap inside the field to bring up the on-screen keyboard and rename it.

The cursor  identifies the active point on the section. The starting point of a section is always zeroed and any additional points that you add are relative to the start point.

Tap on any point that you want to edit. You can either edit the numeric fields directly or you can touch and hold the point with your finger and then drag and drop it to its new position.



TIPS:

- Touch and hold the point you want to edit until its color changes to yellow before you try to drag and drop it to its new position.
 - Zoom in to place your points more accurately. The resolution of the grid will get finer as you zoom in.
-

Note – The lock to grid setting  will affect the positioning of the point when dragging and dropping.

Tap  to delete a selected point or double tap individual points to delete them.



Note – You cannot delete the starting point.

The icons on the bottom of the drawing screen provide useful tools to assist with the drawing of the section. See Common drawing tools.

Tap Save when you are finished.

Edit a section memory

To edit a section memory:

1. In the Target Cross Slope or Target Mainfall screen, select Section from the Type drop-down list.
2. Tap the Memories icon  on the right-hand side of the *Memory* field. The Section Memories screen opens.
3. Select a section and tap the overflow icon  on the right-hand side of the memory. Select Edit. The Edit Section screen opens.
4. Tap inside any of the fields to directly edit them.
5. Tap on the point you want to edit. You can either edit the numeric fields directly or you can touch and hold the point with your finger on the screen and then drag and drop it to its new position.



TIPS:

- Touch and hold the point you want to edit until its color changes to yellow before you try to drag and drop it to its new position.
 - Zoom in to place your points more accurately. The resolution of the grid will get finer as you zoom in.
-

Note – The lock to grid setting  will affect the positioning of the point when dragging and dropping.

6. Tap Save. The Section Memories screen appears and the memory you edited has focus.

Using Cross Slope Guidance

In this chapter:

- ▶ [Using Cross Slope Mode](#)

Cross Slope guidance lets you set and maintain a constant cutting edge slope.

Unlike Design guidance, cross slope guidance does not rely on knowing the machine's three dimensional location.

4.1 Using Cross Slope Mode

Cross Slope guidance lets you set and maintain a constant cutting edge slope, perpendicular to the machine's direction of travel and independent of the rotation of the blade.

Note – These instructions apply to both blade slope and cross slope systems. Use these instructions for either system configuration:

- Blade slope systems measure - blade slope only
- Cross slope systems measure - blade slope, blade rotation and machine mainfall

4.1.1 Selecting Cross Slope guidance

To select Cross Slope guidance while using 2D sensors:

1. From the Dashboard, tap the Machine Setup tile.
2. From the Machine Setup screen, select 2D as the positioning source.
3. From the Sensor Combination field, tap the Open icon . The Sensor Combination screen appears.
4. The sensor combinations that are available on your machine are listed. Select one of the combinations, for example, Cross Slope and tap Apply.
5. You are returned to the Machine Setup screen. Tap Apply.
6. From the Dashboard, tap Start to enter the work screen.



TIP – For quick access to the Sensor Combination screen, touch and hold the sensor combination icon in the guidance bar, at the top of the work screen. Alternatively, a single tap on the icon on the guidance bar will cycle through the Quick Change list that is configured in the Sensor Combination screen.

For less used combinations, use the re-order list icon  to drag them out of the Quick Change list and drop them into the Other Available combination list.

4.1.2 Target cross slope

You can access the Target Cross Slope screen from the Work Settings menu, or you can touch and hold the Target Cross Slope field in the guidance bar.

Use the Target Cross Slope screen to apply a new target cross slope, or to select or edit an existing Target Cross Slope memory. You can also access the Cross Slope Memories screen, which you can use to create target cross slope values that the system saves for later use.

Applying a target cross slope

1. In the guidance bar, touch and hold the Target Cross Slope field to access the Target Cross Slope screen.
2. Either:
 - Enter the value of the cross slope and then tap Apply; or
 - Set the blade on the ground that you want to match the slope of and tap Target Set .

The cross slope target icon in the guidance bar

The cross slope target icon  displays the current target value:

- Tap to cycle through the configured target memories.
- Touch and hold to access the Target Cross Slope screen.

Changing the target cross slope using Inc/Dec switches

You can also change the target cross slope while you operate by using the increment and decrement switches mounted on the control levers or joysticks. Set the desired increment and decrement step size in the Increments screen from the System Settings menu.

4.1.3 Overlays

The overlays icon is in the top right-hand corner of the guidance bar: 

Use this icon to directly access the Overlays screen, which controls what appears on the guidance view.

4.1.4 Autos



Only the tilt of the blade can be controlled by Autos when it is in cross slope mode. You will need to manually control the lift.

4.1.5 Text items

Use the text ribbon area (across the bottom of the guidance view) to display text items of your choice. By default, the system displays ribbon items appropriate for your machine. Useful text items when working with cross slope are:

- Cut/Fill Left and Cut/Fill Right
- Cross Slope
- Blade Slope

Touch and hold any text item in the text ribbon to open the corresponding context menu:

- Tap Add **+** to select a new text item to add to the text ribbon.
- Tap Replace  to select another text item to replace the current one.
- Tap Remove  to remove the current text item from the text ribbon.

At the bottom of the context menu, you can tap Go to Text Ribbon . Alternatively you can access it from the System Settings menu . The Text Ribbon screen allows you to:

- Drag-and-drop items to reorder your list. Alternatively, you can drag a text item in the text ribbon to shuffle it.
- Tap Edit to select which items appear.
- Tap Default to reload the default ribbon items for your machine.
- Enable or disable the display of the text ribbon in the work screen.

4.1.6 System settings

The System Settings icon is on the work screen: 



Use System Settings to access and configure various functions, including (but not limited to):

- Lightbars
- Units
- File Transfer
- Increments (where the inc/dec switches step size can be set)

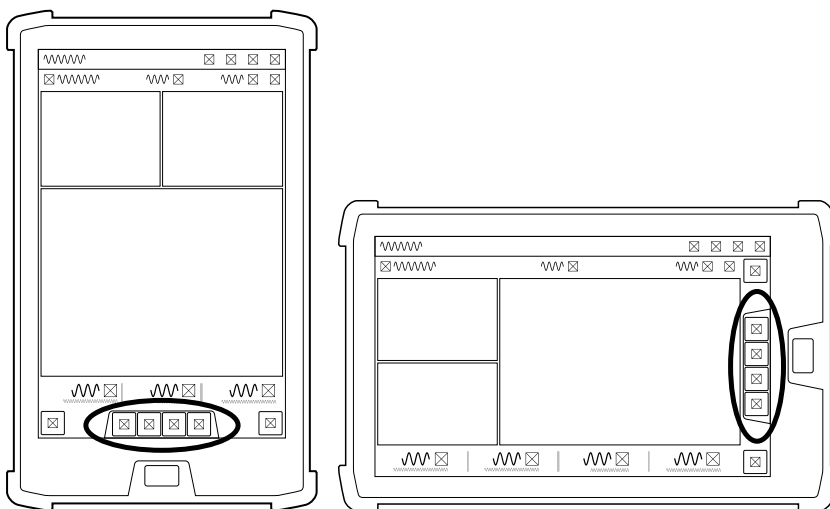
4.1.7 The shortcut bar



The shortcut bar enables you to easily perform frequently repeated tasks. The shortcut icons are for Cross Slope relevant items such as:

- Flip Target Cross Slope . Tap to invert or swap the slope.
- Set Target Cross Slope . Tap to set the current blade cross slope to be the target cross slope. Touch and hold to open the Target Cross Slope screen.

4.1.8 The Back icon

The Back icon is in the top left-hand side of the title bar: 

You can tap the icon or title to return to the previous screen; either the Dashboard or work screen.

4.1.9 Work settings

The Work Settings icon is in the lower right-hand side of the work screen: 

Use the Work Settings menu to access and configure those settings that change according to the requirements of each individual task, including (but not limited to):

- Target Cross Slope
- Flip Target Cross Slope
- Blade
- Auto Mode

Using Design Guidance

In this chapter:

- ▶ Using Design Mode
- ▶ Using Elevation Offsets
- ▶ Horizontal Guidance
- ▶ Vertical Guidance
- ▶ Working with Points
- ▶ Measured Data
- ▶ 3D Line Guidance
- ▶ Lane Guidance
- ▶ Using GNSS

To generate guidance information, the system measures the cutting edge's position relative to a three dimensional (3D) digital map of the design surface. This is called Design guidance. 3D sensors such as GNSS receivers allow the system to always know the machine's three dimensional location.

5.1 Using Design Mode

Design mode lets you select and load a design surface to get guidance to.

Designs include a surface and optional line work. You can select a line and get guidance to it from the blade focus tip.

Use .dsz and .vcl design files that are created in the office in Business Center Heavy Construction Edition. The design files are either automatically downloaded to your system from a cloud service, or you can load them onto your system from a USB drive.

When you select a .vcl design file that contains multiple surfaces, you must further select an individual surface from the file and a master alignment for that surface.

The system supports filled linework in .vcl files. The fill reflects the color set in Business Center Heavy Construction Edition.

5.1.1 Selecting Design mode

1. From the Dashboard, tap the Machine Setup tile.
2. From the Machine Setup screen, select the 3D positioning source that you require and tap Apply.

Note – The positioning source you select will determine the modes that you can select from the Job Setup screen.

3. From the Dashboard, tap the Job Setup tile.
4. From the Job Setup screen select Design as the mode. Also select a project, and design file along with a surface and master alignment (if available).
5. To add reference surfaces, tap  to open Surfaces Manager. Tap Apply.
6. From the Dashboard, tap Start. The work screen appears.

Note – If you select extra linework in Infield mode or Depth and Slope mode, and then change to Design mode, the linework's design will be the default design.



5.1.2 The work screen

In Design mode, this icon (and the name of the selected design) appears at the top left-hand side of the work screen: 

Touch and hold the icon to open the Job Setup screen.

The Design offset icons

The offset icons always appear in the same order left to right on the guidance bar, as shown below:

Horizontal offset	Vertical elevation offset	Perpendicular elevation offset
		

Note – Either the vertical elevation offset **or** perpendicular elevation offset icon appears, depending on which offset type is in use.

Use the offset icons in the following ways:

- Tap to cycle through the configured offset memories.
- Touch and hold to access the respective offset configuration screens.

The offset settings screens

- Use the horizontal offset screen to select a line and configure an offset value.
- Use the elevation offset screen to configure a vertical or perpendicular offset.

Note – If you switch from Design mode to Depth and Slope mode, the system reverts back to an Elevation Offset of 0.00.

5.1.3 Overlays

The overlays icon is in the top right-hand corner of the guidance bar: 

Use this icon to directly access the Overlays screen, which controls what appears on the guidance view.

The guidance view

The guidance view displays the machine relative to the surface being worked. You can set up to three different views to display at once, from the following view types:



- 3D
 - Note* – The 3D view only renders the design surface for a radius of 300 m (about 1000 feet) from the current machine position.
- Cross-section
- Profile
- Plan
- Cut/Fill Left
- Cut/Fill Right
- Cut/Fill Center

Text items

Use the text ribbon (across the bottom of the guidance view) to display text items of your choice. By default, the system displays ribbon items appropriate for your machine. Useful text items for Design mode are:

- Cut/Fill Left
- Cut/Fill Right
- Offline

Touch and hold any text item in the text ribbon to open the corresponding context menu:

- Tap Add  to select a new text item to add to the text ribbon.
- Tap Replace  to select another text item to replace the current one.
- Tap Remove  to remove the current text item from the text ribbon.

At the bottom of the context menu, you can tap Go to Text Ribbon . Alternatively you can access it from the System Settings menu . The Text Ribbon screen allows you to:

- Drag-and-drop items to reorder your list. Alternatively, you can drag a text item in the text ribbon to shuffle it.
- Tap Edit to select which items appear.
- Tap Default to reload the default ribbon items for your machine.
- Enable or disable the display of the text ribbon in the work screen.

5.1.4 System settings

The System Settings icon is on the work screen: 

Use System Settings to access and configure various functions, including (but not limited to):

- Lightbars
- Units
- File Transfer
- Increments (where the inc/dec switches step size can be set)

The shortcut bar

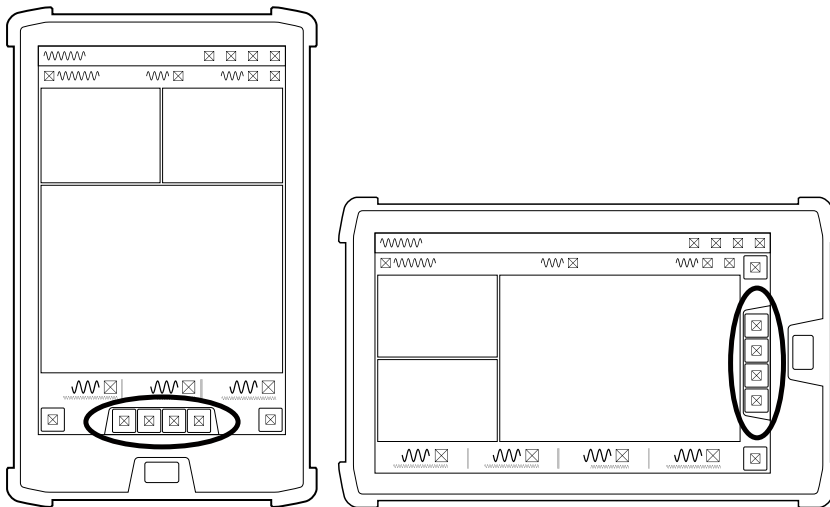

The shortcut bar enables you to easily perform frequently repeated tasks. The shortcut icons are for Design relevant items such as Record Point and Blade Focus.

5.1.5 The Back icon

The Back icon is in the top left-hand side of the title bar: 

You can tap the icon or title to return to the previous screen; either the Dashboard or work screen.

Work settings

The Work Settings icon is in the lower right-hand side of the work screen: 

Use the Work Settings menu to access and configure those settings that change according to the requirements of each individual task, including (but not limited to):

- Auto Mode
- Elevation Offset
- Record Point

5.1.6 For more information

See the following chapters:

- 8.1 Autos Setup - all machines
- 8.2 Autos Optimization
- 8.3 Best Practices when Using Autos

5.2 Using Elevation Offsets

Often, it is not possible to reach the design surface in a single pass, because the elevation of the current ground is too far away from the design surface.

The system lets you apply elevation offsets to the design to create target surfaces that are achievable in a single pass.

You can also use a working surface offset to shift the design surface to a known distance above or below the design surface, for example a subgrade at a known distance below the finished level design.

When using a working surface offset, elevation offsets are applied away from the working surface so you can work the offset down to zero over several passes to reach subgrade for example.



















5.2.1 Accessing the Elevation Offset screen

Perform one of the following actions to access the Elevation Offset screen:

- Open the Work Settings menu .
- Touch and hold the elevation offset field in the guidance bar.

The appearance of the offset icons on the guidance bar depends on:

- The direction of the working surface offset
- The direction of the elevation offset
- The type of offset – vertical or perpendicular

Working Surface Offset	Elevation Offset	Vertical	Perpendicular
Negative	Negative		
	Zero		
	Positive		
Zero	Negative		
	Zero		
	Positive		
Positive	Negative		
	Zero		
	Positive		

5.2.2 The Elevation Offset screen

Use the Elevation Offset screen to:

- Apply or edit an elevation offset
- Select or edit an existing Elevation Offset memory
- Apply or edit a Working Surface offset

You can also access the Offset Memories screen, which you can use to create elevation offset values that the system saves and can be selected for later use.

When you work in Design mode, you can use elevation offsets to do the following tasks:

- Add an offset to the design surface.
- Select an offset from the offset memories.
- Apply a new working surface that is a offset above or below the design surface that you want to achieve at the end of the current task (this is done under Advanced Options).

For example, create a working surface that is 300 mm (1 ft) below the design and bulk shift to that working surface. Then, add material back in offset increments of 50 mm (2 in) each to build back up to the design surface.

- Choose the offset direction (vertical or perpendicular) that applies to both the elevation offset and any working surface offset.

5.2.3 Applying an elevation offset

Use either of the following methods:

- Access the Elevation Offset screen, enter the following data and then tap Apply:
 - Offset value
 - Focus for guidance
 - Offset direction (optional item under Advanced Options):
 - Vertical - typically for a known elevation
 - Perpendicular - typically for a known thickness, particularly on a sloping surface
- Open the work screen and tap the elevation offset field in the guidance bar to cycle through the saved offset memories.
- Use the increment/decrement elevation offset switch to increase or decrease the offset. (To edit the increment values, go to System Settings > Increments.)

5.2.4 Creating, editing or deleting memories

In the Elevation Offset screen:

- Tap the Save button to save an entered offset value as a memory.
- Tap the Memories icon  on the right-hand side of the memory to open the Offset Memories screen.

In the Offset Memories screen:

- Tap the overflow icon  to edit or delete a memory.
- Tap the Create button to create a new memory.
- Touch and hold on a memory to select multiple memories for deletion.

Note – The Save button saves the offset value only. The Working Surface offset and offset direction are not saved.

5.3 Horizontal Guidance

You can receive horizontal guidance relative to the following design features:

- Lines within Office Designs or Infield Designs
- Design surface boundaries

Setting a horizontal offset moves the horizontal guidance away from the selected line. You add or subtract an offset square to the selected horizontal line.

Pass Shift is another way of getting horizontal guidance to a line. Pass Shift moves the guidance line so that the overlap distance with the previous pass is achieved. Use Pass Shift where uniform coverage over an area is required.

Pass Shift is available only on dozers with steering control enabled.



5.3.1 Access the Horizontal Guidance screen

Perform one of the following actions to access the Horizontal Guidance screen:

- Open the Work Settings menu .
- Touch and hold the Pass Shift shortcut key on the shortcut bar.
- Touch and hold the horizontal offset field in the guidance bar.

The horizontal offset icon on the guidance bar appears differently according to the value of the current horizontal offset:

Offset type	Icon	Offset value
Negative		Negative/left of line

Offset type	Icon	Offset value
None		Zero
Positive		Positive/right of line



TIP – The arrows on the selected line indicate the direction of the line. A positive offset is to the right-hand side of the selected line, relative to the direction of the line. A negative offset is to the left-hand side of the selected line, relative to the direction of the line when you look along the line in the direction of the arrows.

5.3.2 The Horizontal Guidance screen

Use the Horizontal Guidance screen to:

- Select a horizontal line to guide to
- Optionally apply an offset
- Optionally apply an overlap value for Pass Shift

Select a line for horizontal guidance

1. Access the Horizontal Guidance screen.
2. If you have not already done so, select a line to guide to. Either select a line from the drop-down list or tap a line on the plan view.
3. Tap Apply.

In the Horizontal Guidance screen, the plan view draws the selected line in red. Arrows indicate the direction of the line.



Alternatively, you can also select a line for horizontal guidance from the context menu in the work screen:

1. From the plan view guidance pane, press and hold anywhere near the line you want to select. A context menu appears.
2. Tap Choose Line and select an available line.
3. Tap Use for guidance.

Note – If you selected a design in the Job Setup menu that contains 3D lines, from the work screen use the shortcut key  or Work Settings menu to open the 3D Line Guidance screen and select a 3D line for guidance.

Apply a horizontal offset

The horizontal offset is the offset distance left (–) or right (+) of the selected line.

1. Access the Horizontal Guidance screen.
2. Optionally, select a line to guide to.
3. Optionally, enter the value of the offset or tap the  or  buttons to increase or decrease the value.
4. To save this as a memory, tap Save.
5. Tap Apply.



When an offset is entered (other than zero), in the Horizontal Guidance screen, the plan view draws the original selected line in cyan. Arrows indicate the direction of the line. A positive offset is to the right-hand side of the selected line, relative to the direction of the line. A negative offset is to the left-hand side of the selected line, relative to the direction of the line when you look along the line in the direction of the arrows.

The guidance line is drawn in red, it is offset from the selected line by the offset value and is the line guidance is provided to.

Tap Memories to select an existing horizontal offset memory or to create the new offset memory values that the system saves for later use.

Applying a horizontal increment

1. Access the Increments screen from the System Settings menu .
2. Optionally, enter the value of the increment in the Horizontal Distance field.
3. Tap Apply.

The horizontal increment value is the amount the horizontal offset changes each time the  or  buttons are tapped in the Horizontal Guidance screen.

If the optional horizontal offset remote switch is installed, each time the rocker switch is pressed the horizontal offset value increments or decrements by the horizontal increment value on the guidance bar. For more information, see The remote switch - if enabled.

Applying an overlap value



1. Access the Horizontal Guidance screen.
2. Optionally, enter the value of the overlap required as either:
 - a. The distance in meters
 - b. A percentage
3. Tap Apply.

Using Pass Shift

When you are in the work screen a pass shift can be applied by using the shortcut keys or by using the optional remote switch if it has been installed. For more information, see The remote switch - if enabled.

The shortcut keys

When you are in the work screen, you can use the shortcut keys to shift the guidance line. The system creates a new guidance line so that the current pass overlaps the previous pass with the overlap value entered in the Horizontal Guidance screen:

1. Tap  to shift the guidance line right of the direction of the guidance line.
2. Tap  to shift the guidance line left of the direction of the guidance line.

If no guidance line is selected, tap either shortcut key to open the Horizontal Guidance screen.

You can also touch and hold either shortcut key to open the Horizontal Guidance screen.

The remote switch - if enabled

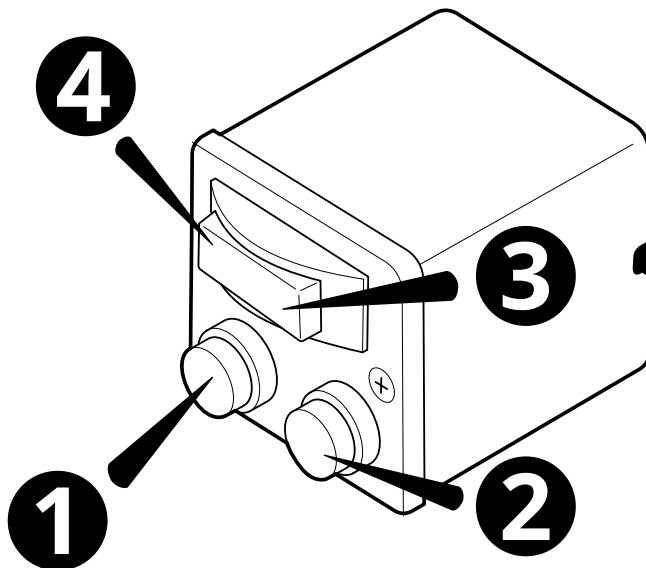

- | | | | |
|---|--|---|--|
| ❶ | Decrement Pass Shift count switch. | ❷ | Increment Pass Shift count switch. |
| ❸ | Increment horizontal distance offset switch. | ❹ | Decrement horizontal distance offset switch. |

5.3.3 Horizontal position information

The center lightbar provides horizontal guidance from the focus to the guidance line. For more information, refer to the *On-screen Lightbars* guide or the *External Lightbars* guide.

In addition to the lightbar, the following text items are also useful:

- **Offline:** Shows the horizontal distance from the guidance point with focus to the guidance line.
- **Guidance Line:** Shows the named line of the line selected for horizontal guidance (if named).
- **Pass Shift:** Shows the number of Pass Shifts made from the guidance line. A negative value means the line was shifted to the left of the direction of the guidance line.
- **Total Horizontal Offset:** Shows the sum of total Pass Shift distance plus the horizontal offset shown in the guidance bar.

5.3.4 Creating, editing or deleting memories

In the Horizontal Guidance screen:

- Tap the Save button to save an entered offset value as a memory.
- Tap the Memories button to open the Horizontal Offset Memories screen.

In the Horizontal Offset Memories screen:

- Tap the overflow icon  to edit or delete a memory.
- Tap the Create button to create a new memory.
- Touch and hold on a memory to select multiple memories for deletion.

5.4 Vertical Guidance

The system calculates the amount of cut/fill between the blade tips and the design surface (or an extension of it) and displays that in the text items and lightbars to guide the operator to build the design surface.



The vertical guidance option selected in the Blade Manager screen changes how the system looks at and extends the design surface beneath the blade to calculate the cut / fill values, so it is important that the correct selection is made for the task you are performing.

This guide will help you understand how the different vertical guidance options work and why you should choose them so that you can determine when you change the selection.

Overcut Protection is also available.

5.4.1 Access the Blade Manager screen

Perform one of the following actions to access the Blade Manager screen:

- Open the Machine Setup tile on the Dashboard and then tap the Blade Manager button.
- Open the Work Settings menu  and tap Blade.
- Touch and hold the Focus shortcut icon  on the shortcut bar.

5.4.2 The Blade Manager screen

Use the Blade Manager screen to:

- Select a focus, or a side of the blade, to guide to. For more information on using the guidance focus, see *Horizontal Guidance*.
- Select a Vertical Guidance
- Optionally apply a Custom Inset
- Optionally toggle Overcut Protection on
- Edit cutting edge length
- Change the current bolt hole selection

Select an option for Vertical Guidance

1. Access the Blade Manager screen.
2. Select a focus, or a side of the blade, to guide to. For more information on using the guidance focus, see *Horizontal Guidance*.
3. Select the Vertical Guidance option for the current task:
 - Right - a single vertical guidance point inset 0.200 m (7.9 inches) from the right cutting edge tip. Use this option when you are using the right side of the cutting edge to build a design that is less than half your blade width, such as a narrow ditch.

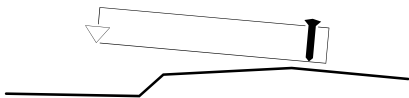

- Center - a single guidance point in the cutting edge center. Use this option when you need to grade material over a change in grade, such as the crown or shoulder of a road. You can extend up to half the blade over the change in grade.



- Left - a single vertical guidance point inset 0.200 m (7.9 inches) from the left cutting edge tip. Use this option when you are using the left side of the cutting edge to build a design that is less than half your cutting edge width, such as a narrow ditch.

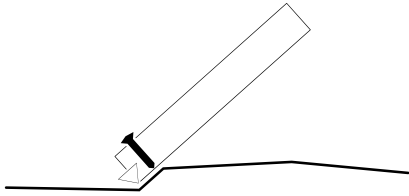

- Linked to focus - a single guidance point inset 0.200 m (7.9 inches) from the cutting edge tip with focus. Use this option when you are building a design that is less than half your cutting edge width, such as grading a narrow ditch from both directions. This guidance point is linked to the Focus and changes when the Focus changes.
- 2 Points - two vertical guidance points, each inset 0.200 m (7.9 inches) from the cutting edge tip. Use this option when you need to average the grade over the cutting edge width, such as when grading a design with smooth curves, like a golf course.

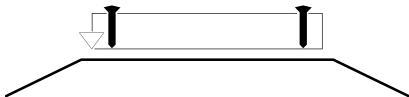

4. Tap Apply.

Design line preview

The system can show an indication of the current design line in the cross section view. This enables you to identify how the cut/fills are being calculated based on the currently-selected vertical guidance point (or points) and the Overcut Protection setting:

1. Access the Overlays screen.
2. Enable the Design Line Preview (Cross Section) toggle. The design line displays on the cross section view as a dashed line.

Apply a custom inset

A custom inset allows you to change the position of the vertical guidance points by entering a custom offset distance from the cutting edge tips.

Note – The custom inset option is available only when using *Linked to Focus* and *2 Points Vertical Guidance* options.

To apply a custom inset:

1. Access the Blade Manager screen.
2. Select either Linked to Focus or 2 Points from the Vertical Guidance menu.
3. Open Advanced Options and toggle Custom Inset on.
4. Optionally update values in one or both of the inset fields. The insets swap sides when the Focus changes.
5. Optionally, toggle Overcut Protection on.
6. Tap Apply.

5.4.3 Overcut Protection

If Overcut Protection is on, the system checks for overcut of the design surface and adjusts the cut/fill guidance to prevent it.

The Overcut Protection check depends on the selected Vertical Guidance:

- When vertical guidance other than 2 Points is selected, the entire length of the cutting edge is checked against the design surface.
- When 2 Points vertical guidance is selected, only the tips of the cutting edge are checked against the design surface.

Overcut Protection is useful when moving material across the toe of a slope, for example moving excess material down from the batter to the floor of the excavation. Toggle Overcut Protection off when the task is done to receive accurate guidance on the rest of the job.

When Overcut Protection is enabled the surface adjusts to protect the toe of the slope.

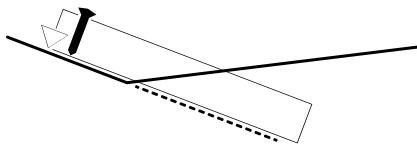

Overcut protection off

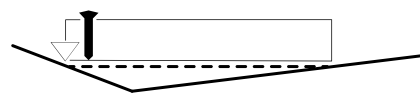

Overcut protection on

5.4.4 Edit the cutting edge length

For information on editing the cutting edge length, update the A and B values in the Cutting Edge Length screen, accessed via the Edit button on the Blade Manager screen.

5.4.5 Troubleshooting

If you are using 1 Point vertical guidance with Overcut Protection on and the cutting edge cuts into the design surface, move the blade so the vertical guidance point is farther away from sharp grade changes.

5.5 Working with Points

Points are available when you are in Design mode and the machine has 3D sensors. If you use GNSS receivers, the machine must be within the GNSS Tolerance Precision.

You can create points in the office or in the field.

5.5.1 Displaying points

To control the appearance of infield points on the work screen, adjust the settings in the Overlays screen. To open the Overlays screen, tap  in the top right-hand corner of the guidance bar. The Points drop-down on the Overlays screen enables you to hide on-screen points, or show combinations of the icon, *Name* and *Code* field.

If you choose to show points with their *Name* and *Code*, the system may truncate the onscreen text so the important parts of the name fit on the screen.

Office points that are included in a layer in a .vcl file are managed the same way as linework within the layer. When you use the Layers Manager screen to:

- Show the layer, the points also display.
- Hide the layer, the points are also hidden. Infield points remain visible.

5.5.2 Filtering points

On the Points Manager screen, you can filter to limit which points appear in the list. You can show:

- All points
- Only points created in the office
- Only points created in the field (all Measured Data stores)
- Only points contained in a specific Measured Data store

5.5.3 Deleting a point

In the Operator app, you can only delete a point that was created in the field. A point created in the office must be deleted from the office software.

When you delete a point created in the field, the system preserves the point so the data is still available to the office. The point is moved from the Measured Data file to a file named *<Measured_Data_name>.<machine_name>.deleted*.

To delete a point:

- From the Points Manager screen, tap the overflow icon  on the right-hand side of the point and select Delete.

- On the work screen:
 - a. Press and hold the point name. The pop-up menu displays.
 - b. Tap > and then tap Delete.

5.5.4 Recording a point

Use Record Point to save the 3D position (Northing, Easting and Elevation) of a point. It is useful for recording points of interest on site, such as the location of a manhole.

Your machine does not have to be stationary to record a point. Whether your machine is moving or stationary, the system records the current position of the focus point *when*:

- you enter the Record Point screen
- you use the Record Point shortcut key 

You can access the Record Point screen from the Work Settings menu . The Record Point screen lets you set up how the system logs the points that you record. It allows you to set specific identifiers for the points, as required for the current job and environment. There are three types of identifiers for points: name, code, and Measured Data.

The Edit Point screen has the same fields as the Record Point screen. It enables you to modify an existing point.

Name

In the Record Point screen, tap in the *Name* field to enter a name for the point.

If a point in the system already has this name (for example Manhole) the system alerts you with a message and adds a numeric suffix to the new point (for example Manhole 3). The suffix automatically increases with each new point that has the same name. This lets you quickly and repeatedly record points via the shortcut key or record point switch without having to enter anything into the Record Point screen.

If you do not enter anything into the *Name* field the name is just the numeric suffix. If you do not specify a suffix, the system generates one automatically. You can edit the name and the suffix as required.

Use this icon  (next to the *Name* field) to select from a list of previously used names.

Code

The *Code* field is a string of text that helps describe the point, for example Mainfall 1. In the Record Point screen, you can manually enter a *Code* string when you record the point, or you can use this icon  to select a string that was predefined in the office software. The predefined *Code* strings are exported from the office software in a .flx file.

If you do not enter anything into the *Code* field, the code will be undefined.

Measured Data

See [Measured Data](#).

Northing, Easting, and Elevation

If the Northing, Easting, and Elevation coordinates are available at the time you access the Record Point screen, they will appear. The coordinates do not change if you move the focus point. You can use the on-screen keypad to enter or change coordinates if required.

The Always Prompt toggle

If Always Prompt is on, the Record Point screen appears each time you tap the Record Point icon in the Work screen. Do this if you want to change the point name, code, or work order for each point you record.

If you want to record a number of points with the same name, code, and Measured Data, set the Always Prompt toggle to off.



Cancel

To discard your changes, tap Cancel. The screen closes and the Work screen appears.

Save

To record the new point, tap Save. The screen closes and the Work screen appears.

5.5.5 How to record a point

1. Place the focus point onto the point that you want to record.
2. To record the point, do one of the following:
 - Access the Record Point screen, enter a name, code, and Measured Data, tap Here and then Save.
 - Touch and hold the Record Point icon in the shortcuts bar ; this opens the Record Point screen. Enter a name, code, and Measured Data, tap Here and then Save.
 - Tap the Record Point icon  to record a point that inherits the last used name (the system adds a numeric suffix to the new point).

5.5.6 Point files

Infield points are stored in a .pnt file. There is a separate .pnt file for each Measured Data, using the naming convention *<measured data>.<machine name>.V01.pnt*.

5.5.7 Navigating to a point

The system can provide navigation to an infield or office point. On the Points Manager screen, tap the overflow menu icon  beside the appropriate point and select Navigate To Point.

When the system provides guidance to a point, the work screen border turns blue and shows a blue line between the focus and the point. The text ribbon shows:

- Nav Direction: the direction to the point relative to the machine direction
- Nav Distance: the horizontal distance to the point
- Nav Depth: the vertical distance to the point

Press this icon  to stop navigation.

5.5.8 Troubleshooting

If the record point icon does not appear in the shortcuts bar, and the Record Point option is not in the Work Settings menu, check that you are in Design mode and that your system includes a 3D sensor.

5.6 Measured Data

Measured Data are containers for points. They enable you to group related points together so you can sort through many points. For example, you might use a Measured Data to group together all points created on a specific day. You can then set filtering to display only the points in that Measured Data.

Measured Data are created in the field.

5.6.1 Creating a Measured Data

You can access the Measured Data screen from the Work Settings menu .

1. From the Measured Data screen, tap Create. The New Measured Data screen appears.
2. Enter a name for the Measured Data and then tap Save. The new Measured Data appears in the list.

Measured Data naming conventions

Measured Data names can be up to 90 characters long.

Avoid using the following in Measured Data names:

- , : * | \ / ?
- Emojis

- Duplicate names

5.6.2 Deleting a Measured Data

You can only delete a Measured Data created in the field. When you delete the Measured Data, the system preserves the points that are contained within it so the office still has access to the data.

You can access the Measured Data screen from the Work Settings menu .

1. On the Measured Data screen, select the Measured Data to delete.
2. Tap the overflow icon  and select Delete. A confirmation dialog appears.
3. Tap Yes to confirm the deletion.

5.6.3 Changing the Measured Data of a point

When you create a point, it is assigned to a Measured Data. You can access the Points Manager screen from the Work Settings menu .

To move a point from one Measured Data to another:

1. On the Points Manager screen, select the point.
2. Tap the overflow icon  on the right-hand side of the point and select Edit. The Edit Point screen appears.
3. Select the new Measured Data from the Measured Data drop-down list.
4. Tap Save to save the point and return to the Points Manager screen.

5.7 3D Line Guidance

3D line designs (.dsz files) contain one or more 3D lines, that represent features such as paths, drains, pipelines and avoidance zones (if available in the Project).

You can do the following with a 3D line design:

- Vary the width of the design surface of a selected 3D line.
- Extend the length of a selected 3D line. This also extends the design surface defined by it.

The cross slope of the design surface defined by a 3D line is always level.

The direction and grade of the design surface defined by a 3D line can change between segments.

A 3D line has named start and end points. The start point is named A and the end point is named B.

5.7.1 Loading a 3D lines file

You need to load a 3D lines file before you can enable 3D line guidance. You can do this from the:

- Dashboard, or;
- Work screen

Dashboard

1. On the Dashboard, tap the Job Setup tile. The Job Setup screen appears.
2. From the Project drop-down, select a project that contains a 3D lines design.
3. From the Modes drop-down, select the Design mode.
4. From the Design drop-down, select a 3D lines file. The image on the left changes to show that the selected file is a 3D lines file.
5. Tap Apply. The Dashboard appears.
6. Tap Start. The work screen appears.
7. Use the shortcut key  or Work Settings menu to open the 3D Line Guidance screen and select a 3D line for guidance.

Work screen

You can access a 3D lines file from either the:

- Guidance bar, or;
- Work Settings menu

Guidance bar

1. On the guidance bar, touch and hold the current file name. The Job Setup screen appears.
2. From the Project drop-down, select a project that contains a 3D lines design.
3. From the Modes drop-down, select the Design mode.
4. From the Design drop-down, select a 3D lines file. The image on the left changes to show that the selected file is a 3D lines file.
5. Tap Apply. The work screen appears.
6. Use the shortcut key  or Work Settings menu to open the 3D Line Guidance screen and enable 3D line guidance.



Work Settings menu

1. Tap the Work Settings icon .
2. Tap the Job Setup menu item. The Job Setup screen appears.
3. From the Project drop-down, select a project that contains a 3D lines design.
4. From the Modes drop-down, select the Design mode.

5. From the Design drop-down, select a 3D lines file. The image on the left changes to show that the selected file is a 3D lines file.
6. Tap Apply. The work screen appears.
7. Use the shortcut key  or Work Settings menu to open the 3D Line Guidance screen and enable 3D line guidance.

5.7.2 Accessing the 3D Line Guidance screen

To access the 3D Line Guidance screen (from the work screen) you can either:

- Tap the shortcut key , or;
- Go to the Work Settings menu  > 3D Line Guidance.

Note – The shortcut key does not appear in the work screen until you load a 3D lines file.

5.7.3 Selecting a 3D line for guidance

1. Access the 3D Line Guidance screen.
2. In the plan view, select the line that you want to work with. You can pan and zoom the plan view as required.
3. Set the surface width. The value must be between 0.10 of a meter and 50.00 meters (4 inches and 164 feet).
4. To extend the length of the line, expand Advanced Options and enter the end point extension lengths. The maximum length that you can add is 100 meters (328 feet).
5. Tap Apply. The work screen appears with the selected line shown in red. Any end point extensions appear as a dashed red line, and the guidance surface that is generated appears in dark gray.

5.7.4 Changing 3D line guidance

To change the line that you want to get 3D line guidance to:

1. Access the 3D Line Guidance screen.
2. The currently selected line appears in the plan view. Select the 3D line you want to get guidance to.
3. Set the Surface Width.
4. If required, expand Advanced Options and enter the end point lengths.
5. Tap Apply. The work screen appears with the line shown as a surface.

5.7.5 Lightbar guidance to a 3D line

You can use the vertical guidance and horizontal guidance lightbars to guide you to your chosen 3D line.

5.7.6 Useful text items

- Cut/Fill Left
- Cut/Fill Center
- Cut/Fill Right
- MA Offset (you can use this to gauge how far you are from your chosen 3D line).

5.8 Lane Guidance

Lane guidance enables you to work in two different ways:

- Holding a blade onto a surface or lane
- Extending a lane sideways

Lane guidance is available when:

- You are in design mode
- You have a .dsz design loaded
- A master alignment is present

Working surface, vertical and perpendicular lifts and horizontal guidance all work with lane guidance.

Note – When you show cut/fill mapping while using lane guidance, you see a subset of the entire mapped ground surface. This is most noticeable when using lane guidance on a horizontal curve. Toggle lane guidance off to display the ground surface mapping over the complete design reference.

5.8.1 Holding your blade onto a surface or lane

When working on narrow surfaces such as a v-ditch, you can use lane guidance to extend the slope of the v-ditch so that you can build that slope with a blade that is wider than the v-ditch. The system only gives guidance to your chosen lane.

5.8.2 Extending a lane sideways

Lane guidance lets you select a lane or two lines and extend the surface of the lane or the grade between the two lines out to the left and right, to suit different situations.

For example, you can select a lane for guidance and extend it to the side to either meet the cut or fill batter or sideslope of the road. This is often also offset in height as well so that the design is built up in layers. See the figure below:

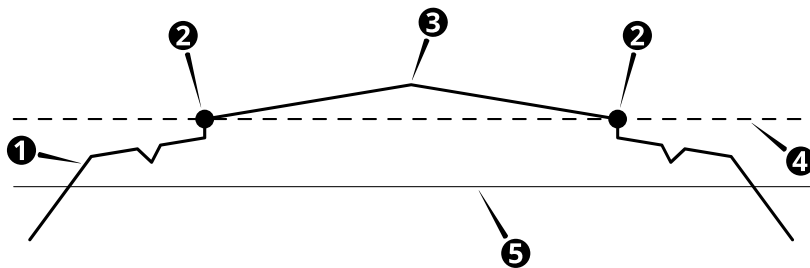

1	Original design	2	Lane side	3	Master alignment
4	Lane surface	5	Lane surface for guidance (offset by 1 meter)		

You can also use lane guidance to suit a particular stage in a project. For example, while building the cross slope of the left-hand lane, the lane is extended over the crown so that excess material is cast over the crown onto the right-hand lane. The material in the right-hand lane is dealt with at a later time. See the figure below:

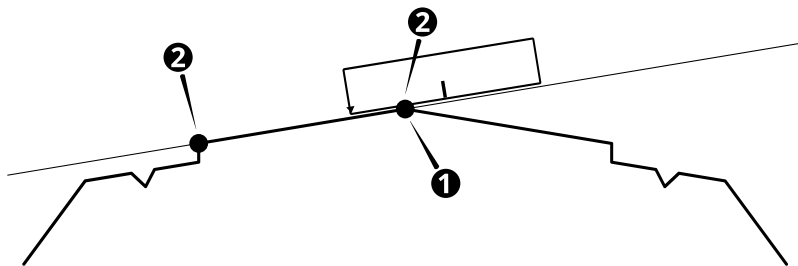

1	Master alignment	2	Lane side
---	------------------	---	-----------

5.8.3 The shortcut key

When you are in the work screen, you can use the shortcut key  to select a lane:



1. Position the machine with the blade focus point between the required lane sides.
2. Position the machine with the screed focus point between the required lane sides.
3. Tap .

You can also touch and hold the shortcut key to open the Lane Guidance screen.

If your design does not have a master alignment, and you try to enable Lane Guidance via the shortcut key, the Select Master Alignment screen appears. In the plan view, tap the line that you want to use or select a named alignment from the drop-down list. Once you have selected a master alignment, the work screen appears.

5.8.4 The Lane Guidance screen

To open the Lane Guidance screen:

- Touch and hold the shortcut key , or;
- Go to the Work Settings menu  > Lane Guidance.

The Lane Guidance screen contains a plan view of the machine on a design. You can pan and zoom this view as required.

If the .dsz file contains named lines, you can select them from the Line A and Line B drop-down lists.

The master alignment

The lane surface is calculated at right angles to the master alignment.

If the .dsz file contains a master alignment, it appears in the plan view as a solid blue line. You must use this master alignment and cannot change it.

If the .dsz file does not contain a master alignment, you must select one before you select the lane sides:

1. Touch and hold . The Select Master Alignment screen appears.
2. In the plan view, tap the alignment that you want to use as the master alignment. Or, select an alignment from the drop-down list.

The master alignment is stored with the design indefinitely. If the design is unloaded and reloaded then the last selected master alignment is used.

Note – Think of the two lane sides and master alignment as a group. If you change the master alignment, but not the lane sides, this changes the lane surface and the guidance to it.

You can use the master alignment itself as one of the sides of the lane.

Creating a lane surface

To create a lane surface from the Lane Guidance screen, do one of the following:

- Select the alignments from the drop-down lists.
- Tap each lane side on the plan view.
- Touch and hold the area between two lane sides.

5.8.5 Lane Guidance limits

- The lane must be a minimum of 300mm (12in) wide.
- The lane sides must not turn more than 90° away from the master alignment.
- Lane Guidance starts only when all three lines (the master alignment, left-hand lane side and right-hand lane side) have started. See the figure below:

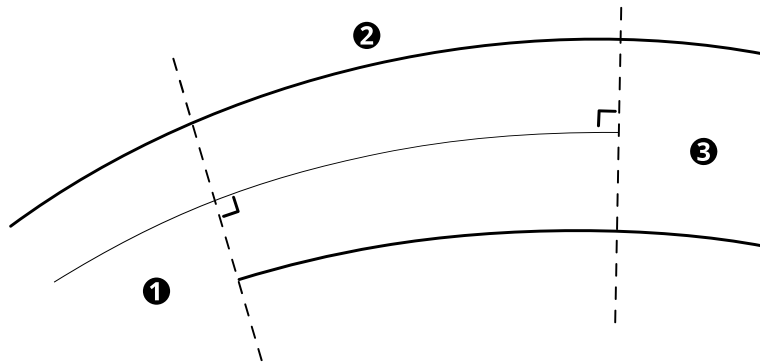

❶ Lane guidance unavailable: only one lane side is present

❷ Lane guidance available: two lane sides and the master alignment are present

❸ Lane guidance unavailable: no master alignment present

5.8.6 Troubleshooting

Lane guidance is unavailable when:

- You are more than 100 meters extension (left/right) of the guidance lane sides.
- Either lane side does not lie above the design surface.

5.9 Using GNSS

5.9.1 Troubleshooting

The table below lists some of the error messages that may appear in the work screen and common error states during operation.

Operational State	Problem	Solution
Coordinate System Failed To Load. Unable to load the coordinate	One or more of the coordinate system files, or the site calibration file, may be corrupt.	Contact your technician, site engineer, or surveyor.

Operational State	Problem	Solution
system for the current project.		
Coordinate System Failed To Load. <filename>not specified in coordinate system database XML.	A file that is referenced in the project site calibration is not included in the coordinate system database. The coordinate system database may need to be updated to include the required file.	Contact your technician, site engineer, or surveyor.
Coordinate System Failed To Load. <filename> is missing or invalid.	A file that is referenced in the project site calibration is not present in the GeoData on the EC520.	Contact your technician, site engineer, or surveyor.
GNSS Error. Autonomous GNSS.	The GNSS receiver is tracking satellites but there are no valid corrections.	Check the radio and cables. Check that the channel setting for the radio matches that of the base station. Ask your site supervisor to check that the GNSS base station and any repeaters in the radio network are working correctly.
GNSS Error. No GNSS Position.	The GNSS receiver is not outputting data.	Check the GNSS receiver and cables, and ensure the antennas have a clear view of the sky.
GNSS Error. Old GNSS Position.	The GNSS receiver is not tracking enough satellites, or is still acquiring satellites and not yet computing a valid position.	Check the GNSS cables and receiver for faults, and ensure the antennas have a clear view of the sky.
GNSS Error. Out of Geoid Range.	The GNSS position is out of the range of the loaded geoid grid, or the correct project or Geoid has not been loaded.	Move the machine into range, or load a project with the correct Geoid for your location. If problems continue, contact your technician, site engineer, or surveyor.
New Base	The base station radio	Contact your site supervisor.

Operational State	Problem	Solution
Station Coordinates Detected. Continued operation may give poor results. Contact your site supervisor.	channel set up for your system, is also being used by another base station within radio range.	
Sensor Invalid. GNSS Receiver - Left/Right is disconnected.	Only one of the GNSS receivers is generating positions.	Check the cable and power for the receiver. If problems continue, contact your site supervisor.
Sensors warming up, accuracy could be degraded.	The sensor or sensors are below the minimum temperature required to provide accurate guidance.	Wait while the internal sensor heaters warm the sensors up to the minimum temperature required for accurate guidance. When the sensors reach the minimum temperature, the 'Initialization required, stay stationary and tap Restart' message displays. You can move the machine while waiting for the initialization to complete.

Using Infield Guidance

In this chapter:

- ▶ [Infield Designs](#)

This chapter introduces the use of infield designs.

6.1 Infield Designs

Infield designs enable you to create 3D designs in the cab. Using the design wizard, you can create a simple design surface or a complex alignment with a cross-section applied to it.

To begin creating an infield design, do the following:

1. In the Job Setup screen, select a project and then go to the *Mode* field and select Infield.

The *Extra Linework (optional)* field displays if you have a 3D guidance solution. This helps you to reference an office design on the work screen.

Note – Access to extra linework is enabled or disabled by your technician. 3D line designs are not available to select. Horizontal guidance to the extra linework is not available.

2. Tap the open icon  on the right-hand side of the *Design* field. The Infield Designs screen opens.
3. Tap Create.
4. Tap Level  or Slope  to create a simple design; tap Alignment and Section  to draw an alignment and section and then combine the two.



TIP - Load extra linework when you view the completed infield design on the work screen.

6.1.1 Level pad design

To create a level pad design, select your guidance focus and then set an elevation.



TIP - Tap  Here to use the current Elevation of the focus point.

6.1.2 Slope design

There are four steps to creating a slope:

1. Select the guidance focus and then set the coordinates of the initial point in your alignment.
2. Select the slope type.
 - Point and Direction. Create a slope design by combining an initial point with a defined direction and grade.
 - 2-Point. Create a slope design using two points in the path of your alignment.

3. Define the surface.

For the Point and Direction method, enter angles for the direction of the path of your alignment and the grade for the mainfall slope of your design in the direction specified.

For the 2-Point method, select the blade focus and then set the coordinates of a second point, which defines the direction and grade of your alignment.

4. Enter the angle of the cross slope. For a dual cross slope, enter the left and right angles of the slope.



TIPS:

- Tap  Here to use the current coordinates of the focus point.
 - Tap Level to set the angle(s) of the cross slope to 0%.
 - When you change the Slope Type from 2-Point to Point and Direction, the new field values are calculated from the values entered for the two points. Use this to check if the calculated direction and grade are within design limits.
-

6.1.3 Alignment & Section design



When you create an Alignment & Section, you will be guided through a 3-step process:

1. Create an alignment.
 - Create the points that define the path of the alignment (Plan view).
 - Adjust the elevation of the points to establish the grade of the alignment (Elevation view).
2. Create a section.
3. Combine the section and alignment to create a 3D model of the infield design.

You can create an infield design with your blade tip directly on screen or using an existing template.

Step 1: Create alignment



Select one of the drawing methods described in the following table.

Icon	Method and description
	Drawing with points. Use points that you have recorded on your work screen or points imported from the office.
	Drawing with the blade focus. Use the focus of your blade tip to define alignment points.
	Importing an existing alignment. Use an existing alignment as a template. You can edit it and save it as a new alignment.

Alignment editing modes

The different editing modes described in the table below are common to each of the alignment drawing methods.

By default, the edit coordinate mode  is selected. Tap to select the editing mode you prefer.

Icon	Mode and description
	Edit Coordinate. Use this to edit the Northing, Easting and/or Elevation of a point.
	Edit Segment. Use this to edit the distance, internal angle and elevation of a point.

There are two steps to creating an alignment:

1. Create the points that define the path of the alignment ([Plan view](#)).
2. Adjust the elevation of the points to establish the grade of the alignment ([Elevation view](#)).



TIP - Tap inside any field to directly edit it.

Drawing with points

Plan view

You can use points that you have previously recorded on the work screen or those that have been imported from the office to create a new alignment. Tap  to select a point from the Points screen and add it to the alignment.

Use the filters on the Points screen to view only the points that were recorded on the work screen, imported from the office, or both.

Office points are stored in office-created projects. To use any available office points, first select the Office project in Job Setup.



TIP - Use the plan view preview to quickly check the placement of your points in your work area. Points that you have selected are highlighted.

Note – The work area displayed in the plan view preview is the design selected in Job Setup. If you have not selected a design, the plan view preview displays the last selected design.

The cursor  identifies the active point. Additional points are relative to the origin point.

Note – Once an origin point has been created it cannot be edited as all the other points created are positioned relative to this point. To change the origin point, tap  and create a new one.

Tap  to undo your last action. Tap  to delete a selected point or double tap individual points to delete them.

Tap the point you want to edit and then, either edit the numeric fields directly, or drag and drop it to a new position.



TIPS:

- Touch and hold the point you want to edit until its color changes to yellow before you try to drag and drop it to its new position.
 - Zoom in to place your points more accurately. The resolution of the grid will get finer as you zoom in.
-

Note – The lock to grid setting  will affect the positioning of the point when dragging and dropping.

The icons in the toolbar provide useful tools for creating your design. See [Common drawing tools](#).

Elevation view

After you create the points that define the path of the alignment, tap the Elevation view tab to define the grade of the alignment by adjusting the elevation of the points.

This view shows the elevation of all points along the length of the alignment. By default, the first and last points in the alignment are active . The black dotted line indicates a consistent grade between the two points.

Note – Select any two points on the line by touching them in succession to make them active.

The black dots show the change in elevation between the active points.

Once you select the segments bound by the active points, tap the Align Vertices button  to align the segments between the active points. This is useful if you need to apply the same slope or grade to a series of segments.

Note – The Align Vertices button is only available in Elevation view and is only enabled after you create three or more points.

Note – If you alter any of the horizontal positions in the Plan view, you must also check the Elevation view and make adjustments if necessary.

Tap Next when you are finished.

Drawing with the blade focus

Plan view

You can use your blade focus to create a new alignment. Tap the Focus icon  to select an alternative focus point.

The cursor  identifies the active point. Additional points are relative to the origin point.

Note – Once an origin point has been created it cannot be edited as all the other points created are positioned relative to this point. To change the origin point, tap  and create a new one.

Each time you move the blade to the next point, tap the Add Point icon .

Tap  to undo your last action. Tap  to delete a selected point or double tap individual points to delete them.

After using the blade focus to create a point, you can edit it.

Tap the point you want to edit and then, either edit the numeric fields directly, or drag and drop it to a new position.



TIPS:

- Touch and hold the point you want to edit until its color changes to yellow before you try to drag and drop it to its new position.
 - Zoom in to place your points more accurately. The resolution of the grid will get finer as you zoom in.
-

Note – The lock to grid setting  will affect the positioning of the point when dragging and dropping.

The icons in the toolbar provide useful tools for creating your design. See [Common drawing tools](#).

Elevation view

After you create the points that define the path of the alignment, tap the Elevation view tab to define the grade of the alignment by adjusting the elevation of the points.

This view shows the elevation of all points along the length of the alignment. By default, the first and last points in the alignment are active . The black dotted line indicates a consistent grade between the two points.

Note – Select any two points on the line by touching them in succession to make them active.

The black dots show the change in elevation between the active points.

Once you select the segments bound by the active points, tap the Align Vertices button  to align the segments between the active points. This is useful if you need to apply the same slope or grade to a series of segments.

Note – The Align Vertices button is only available in Elevation view and is only enabled after you create three or more points.

Note – If you alter any of the horizontal positions in the Plan view, you must also check the Elevation view and make adjustments if necessary.

Tap Next when you are finished.

Importing an existing alignment

You can use an existing alignment as a template. You can then edit and save it as a new alignment.

Note – Any alignments you create as part of an infield design will be included in the list of available templates.

The cursor  identifies the active point. Additional points are relative to the origin point.

Note – Once an origin point has been created it cannot be edited as all the other points created are positioned relative to this point. To change the origin point, tap  and create a new one.

Tap the point you want to edit and then, either edit the numeric fields directly, or drag and drop it to a new position.



TIPS:

- Touch and hold the point you want to edit until its color changes to yellow before you try to drag and drop it to its new position.
- Zoom in to place your points more accurately. The resolution of the grid will get finer as you zoom in.

Note – The lock to grid setting  will affect the positioning of the point when dragging and dropping.



TIP – To add a new point in the middle of a segment, touch the first point to highlight it and then tap .

Tap  to undo your last action. Tap  to delete a selected point or double tap individual points to delete them.

The icons in the toolbar provide useful tools for creating your design. See [Common drawing tools](#).



Tap Next when you are finished.

Step 2: Create Section

Sections are like templates that define roads, banks and channels. A section consists of a number segments.

To create a section, use one of the methods described in the following table.





Icon	Method and description
	Drawing directly on-screen with your finger . Use your finger directly on the screen to define section points.

Icon	Method and description
	Drawing with the blade focus . Use the blade focus to define section points.
	Importing an existing section . Use an existing section memory as a template. You can edit it and save it as a new section memory.

Section editing modes

The different editing modes described in the table below are common to each of the section creation modes.

By default, the edit line mode  is selected. Tap to select the editing mode you prefer.

Icon	Mode and description
	Edit Point. In edit point mode you use relative measurements to specify a point's position (like rise over run).
	Edit Line. In edit line mode you use an angle and a horizontal distance from the previous point to specify a point's position.
	Scale All. In scale all mode you use a width and a height to specify the sections size. <i>Note</i> – In scale all mode,  indicates that the height and width ratio will be maintained on scaling. Tap to adjust these measures independently of each other ( .



TIP - Tap inside any field to directly edit it.

Drawing directly on-screen with your finger

You can draw points directly on the screen with your finger to create a new section and then save it.

The cursor  identifies the active point. Additional points are relative to the origin point.

Every time you lift your finger off the screen a new point is added.

Tap the point you want to edit and then, either edit the numeric fields directly, or drag and drop it to a new position.

Tap  to undo your last action. Tap  to delete a selected point or double tap individual points to delete them.

The icons in the toolbar provide useful tools for creating your design. See [Common drawing tools](#).

Tap Next when you are finished.

Drawing with the blade focus

You can use your blade focus to create a new section. Tap the Focus icon  to select an alternative focus point.

Each time you move the blade to the next point, tap the Add Point icon .

Tap the point you want to edit and then, either edit the numeric fields directly, or drag and drop it to a new position.

After using the blade focus to create a point, you can edit it.

Tap the point you want to edit and then, either edit the numeric fields directly, or drag and drop it to a new position.



TIPS:

- Touch and hold the point you want to edit until its color changes to yellow before you try to drag and drop it to its new position.
 - Zoom in to place your points more accurately. The resolution of the grid will get finer as you zoom in.
-

Note – The lock to grid setting  will affect the positioning of the point when dragging and dropping.

The icons in the toolbar provide useful tools for creating your design. See [Common drawing tools](#).

Tap Next when you are finished.

Importing an existing section

You can use an existing section as a template. You can then edit and save it as a new section.

The cursor  identifies the active point. Additional points are relative to the origin point.

Note – Once an origin point has been created it cannot be edited as all the other points created are positioned relative to this point. To change the origin point, tap  and create a new one.

Tap the point you want to edit and then, either edit the numeric fields directly, or drag and drop it to a new position.



TIPS:

- Touch and hold the point you want to edit until its color changes to yellow before you try to drag and drop it to its new position.
 - Zoom in to place your points more accurately. The resolution of the grid will get finer as you zoom in.
-

Note – The lock to grid setting  will affect the positioning of the point when dragging and dropping.

Tap  to undo your last action. Tap  to delete a selected point or double tap individual points to delete them.

The icons in the toolbar provide useful tools for creating your design. See [Common drawing tools](#).







Tap Next when you are finished.

Step 3: Combine Alignment and Section



In this final step, the section is attached to the alignment. By default, the first point of the section acts like an anchor and is attached to the alignment.

Drawing tools

The icons on the drawing screen provide useful tools to assist with combining the alignment and section.

Icon	Description
	Enter the distance to extend the design back from the first point defined in the alignment. The maximum value is 500 m.
	Enter the distance to extend the design beyond the last point defined in the alignment. The maximum value is 500 m.
	Tap to move the intersection of the section and alignment to the previous point.
	Tap to move the intersection of the section and alignment to the next point.
	Tap to horizontally flip the section without changing the intersection of the section and alignment. Use this feature if the section is attached to the wrong side of the alignment and you need to flip it to the other side. For example, if the section is attached to the left side of the alignment and needs to be on the right side, or vice-versa.
	Tap to reset the zoom and display the entire drawing in the view.

Plan view

To edit the intersection point of the section, tap the Next Point  and/or Previous Point  icons. The axes hairs show you where the section and alignment intersect.

3D view

Use the 3D view to perform a sanity check on the design.



TIP - Zoom in to inspect the design closely.

The system automatically assigns the next available name to the design, for example: "Infield 2". If required, tap inside the *Name* field and enter another name.

Tap Apply.

Common drawing tools

The icons on the drawing screen provide useful tools to assist you with drawing alignments or sections.

Icon	Description
	Tap to undo the last action.
	Mirror the existing section either from the origin point or from the end point. Select the mirroring direction in the pop-over box. Select to replicate and reflect the section and attach it to the end. Select to replicate and reflect the section and attach it to the origin. <i>Note – This is not available for Step 1: Create Alignment.</i>
	Tap to reset the zoom and display the entire drawing in the view.
	Lock to Grid. New points are placed on the nearest intersection on the drawing grid.
	Unlock from Grid. New points are placed anywhere in the drawing window. Tap to switch between the modes. <i>Note – Lock to Grid only applies to points created or edited on-screen by touch.</i>

Tips to avoid overlapping surfaces in infield designs

Using the Alignment and Section method to create infield designs can create designs with overlapping surfaces. The system may fail to give guidance to overlapping surfaces.

To use the Alignment and Section method to create designs with no overlapping surfaces, create alignments that:

- Are straight or with wide corners and curves.
- Start and end on straight portions - if the design must close on itself. Leave a small gap between the alignment's start and end.
- Have shallow or smooth elevation changes.

- Are along the inside edges of the desired surfaces so that placing the sections creates surfaces along the open sides of the alignments.
- Have narrow cross sections, especially on designs with corners or curves.

When you combine the alignment and section, use the 3D view to check for:

- Overlapping sections - dark gray
- Missing sections - no gray
- Poorly formed sections - possible poor guidance points

Using Single-3D Guidance

In this chapter:

- ▶ [Using UTS for Guidance](#)
- ▶ [Best Practices When Using Single-3D Guidance](#)

You can use an MT900 Machine target with a Universal Total Station or a single GNSS receiver to provide high precision 3D guidance to both cutting edge tips.

A UTS system is able to provide higher accuracy positioning than GNSS, and can continue to work in circumstances that would usually degrade GNSS performance.

7.1 Using UTS for Guidance

Configure the machine to connect to a Universal Total Station (UTS) instrument for machine guidance.

To enable UTS guidance, select a UTS option as the positioning source in the Machine Setup screen.

7.1.1 The UTS Settings screen

The UTS Settings screen enables you to set the radio network ID and channel that both the system and UTS instrument communicate over. Ensure that the Channel and Network ID settings chosen on the machine match those set on the UTS instrument.

Note – Ensure that the UTS instrument has been set up in Machine Control mode using Trimble SCS900 or Siteworks and that the small screen on the front of the UTS instrument displays "Waiting for connection".

Note – Ensure that each machine using UTS guidance in the same area of a site has a unique Target ID for its MT900 Machine Target.



TIPS:

- Look at the small screen on the front of the UTS instrument to check which Channel and Network ID it is using.
 - In the UTS Settings screen, toggle Auto Search off if you prefer to move the machine back to the last tracked position where the MT900 Machine Target was lost and manually start a search.
-

If you have an Operator Plus account you can configure the UTS tolerance thresholds via the Advanced button on the UTS Settings screen.

7.1.2 The UTS Management screen

The UTS Management screen enables you to select and use UTS instruments that are on the same radio channel and network as the machine and within radio range of the machine.

The system supports connection to a maximum of five UTS instruments.



TIPS:



- For best accuracy, select an instrument to use for guidance that is less than 200 m from the machine
 - Set a custom name for your Trimble SPSx30 Total Station using Trimble SCS900 or Siteworks software.
-

Note – Use Trimble SCS900 or Siteworks software to connect to and set up UTS instruments in Machine Control mode before connecting to them from the machine. The accuracy of guidance on the machine depends on an accurate UTS instrument setup.

Note – The system will clear the bench and transition offsets if you stop the UTS instrument currently being used for guidance and start it again in a different position, or if you start using a different UTS instrument. A confirmation message **Bench and Transition Offsets will be Cleared** is displayed before you can use the UTS instrument for guidance.

Note – Tap within the UTS Name or Status column area to start or use the UTS instrument for guidance. Tapping on a UTS instrument row in any other areas will not be recognized. This prevents unintentional activation when your fingers are close to the screen in those columns.

Understanding UTS statuses

Item	Function
Configuring	Appears after you have tapped a UTS instrument to start it and while a radio connection is being established with it.
Searching	Appears when the UTS instrument is searching for the target.
Tracking	Appears when a UTS instrument is tracking the target.
Used for Guidance	Appears instead of the status of Tracking for the UTS instrument that you have tapped to use for guidance. The UTS instrument providing guidance is listed at the top and is highlighted orange.
Target Lost	Appears when the UTS instrument is not tracking the machine target and a search has failed to find the machine target, or when auto search is disabled and the UTS instrument is not tracking the machine target <i>and</i> you have not started a search.
UTS out of level	Appears when a UTS instrument reports that it is out of level. To correct this, stop the connection to that UTS instrument using the overflow menu  , re-level it and redo the UTS Instrument setup using Trimble SCS900 or Siteworks before starting it again from the machine.
Configuration failed	Appears after you tap to start a UTS instrument but the radio connection to it from the machine fails to be successfully established. To correct this, stop the connection to that UTS instrument using the overflow menu  and redo the UTS Instrument setup using Trimble SCS900 or Siteworks before starting it again from the machine.
Out of Range	Appears if your UTS instrument is positioned at a distance greater than the Maximum Distance limit set for UTS tolerances. For more information, see Understanding UTS tolerances.

Understanding Horizontal and Vertical Differences

UTS guidance accuracy decreases as the distance increases from the UTS instrument used for guidance. Some jobs require using more than one UTS instrument to ensure accurate guidance over the length of a pass. In this case, you must transition between UTS instruments as the machine moves along the pass.

When multiple UTS instruments are used for a pass, the horizontal and vertical difference values displayed in the UTS Management screen are the differences between the target position reported by the UTS instrument used for guidance and the positions reported by any other UTS instruments tracking that target. The horizontal and vertical difference values provide an indication of the quality of the UTS instrument setup along a pass.

The first UTS instrument to track a target is assumed to have zero error. At each transition between UTS instruments, the horizontal and vertical differences between the previous UTS instrument and the new UTS instrument are compensated for by the system. These compensations accumulate with each transition into a value referred to as the transition offsets.







ATTENTION – If an action is performed that resets the transition offsets to zero during a pass, then there may be significant changes to the elevation of the formed surface and to horizontal guidance.

Understanding UTS information

Several icons appear in the UTS Management and work screens.

Icon	Description
	Displays when the distance to the UTS instrument has exceeded the warning threshold. For more information, see Understanding UTS tolerances .
	Displays when the distance to the UTS instrument is outside of the distance or position tolerances. For more information, see Understanding UTS tolerances .
	Tap to display the overflow menu for an instrument in the list. Use the overflow options as follows: <ul style="list-style-type: none"> Tap to establish the radio connection to a UTS instrument and move it to the Connected Instruments list. <p><i>Note</i> – Once a UTS instrument is started by a machine it is not available for other machines or surveyors to connect to.</p> Tap to use a connected UTS instrument for guidance. <p><i>Note</i> – Not available when the UTS instrument is out of range or is outside of the distance or position tolerances. For more information, see Understanding UTS tolerances.</p>

Icon	Description
	<ul style="list-style-type: none"> • Tap  to stop using the UTS instrument. This makes it available for other machines or surveyors on site to use. • Tap  to activate a search for the UTS instrument to find the MT900 target if it has lost tracking. • Tap  to cancel a search in progress. • Tap  to view diagnostic information for the UTS instrument and the machine target.
	Displays when the UTS instrument is connected to an external power source.

Understanding UTS diagnostics

The Diagnostics pop-up information box displays status information for the UTS instrument and the MT900 machine target. Use this information to troubleshoot errors during operation.

The information box displays the name of the UTS instrument and its current status.

UTS

The fields in this area display status information for the UTS instrument.

Field	Explanation
Northing Easting Elevation	The setup location of the UTS instrument.
Compensator	The instrument's compensator status. For best results, ensure that this is enabled.
Instrument height	The setup height of the UTS instrument above a known control point.
Scale factor	The scale factor set on the UTS instrument.
PPM	The offset that corrects the error in the UTS instrument's Electronic Distance Meter (EDM) caused by temperature and pressure.
Point Name	The name of the point at which the UTS instrument was set up.

Machine Target

The fields in this area display the status of the machine target.

Field	Explanation
Northing Easting Elevation	The location of the center of the machine target as measured by the UTS instrument, but adjusted for mast lean.
Search window	The position of the machine target relative to the search window specified during UTS instrument set up.
Slope distance Horizontal angle Vertical angle	The observed location of the machine target relative to the UTS instrument.

Understanding UTS tolerances

If you are using more than one UTS instrument and are transitioning between them, you can configure the acceptable thresholds for the distance and position differences between the UTS instruments in the Web Interface. Use the thresholds to disable transitions between UTS instruments outside tolerances.

In the work screen, the following information is displayed for UTS instruments:

- The text ribbon can be configured to display a text item that shows which MT900 machine target on the machine is currently being tracked and its distance from the UTS instrument.
- The plan view displays the location of UTS instruments available on site. An orange icon indicates the UTS instrument in use.

Bench UTS

Benching matches the cutting edge elevation to a known elevation on site. It *does not* match the Northing or Easting horizontal position.



TIP – You can access the Bench UTS screen from the work settings menu or by tapping the Bench button in the UTS Management screen.

To bench:

1. Open the Bench UTS screen.
2. Position the cutting edge over the benchmark. You may move the machine or the blade to achieve this.
3. Level the blade using the Current Reading of the slope displayed on the Bench UTS screen.
4. Using a tape measure, measure up from the benchmark to the cutting edge tip.
5. In the Blade Tip field, select which tip you want to bench: Left or Right.

6. Add the elevation of the benchmark and the value measured in step 4. Write this value down and then enter that value into the Elevation - (A) field.
7. Tap Bench.
8. Before moving the machine go back into the Bench UTS screen and check that the Last Bench Elevation displayed matches the elevation written down in step 6.

Common UTS problems

Problem	Action
UTS instrument not displayed in UTS Management screen	Check that the radio channel and network on the machine are set correctly to match those of the UTS instrument.
UTS instrument tracks the Machine Target on another machine	In the UTS Settings screen, change the target ID on the machine. Ensure that each machine using UTS guidance in the same area of a site has a unique Target ID for its MT900 Machine Target.
Surveyor checking grade behind the machine finds that it does not match	<p>Ensure the following:</p> <ul style="list-style-type: none"> • Machine has been benched. For more information, see Bench UTS. • The same design is being used on the machine and by the surveyor. • The same vertical offset is being used by the machine and the surveyor. • The surveyor has set up their instrument position accurately and agrees with the elevation on the benchmark used by the machine. For more information, see Bench UTS. • The surveyor has the correct pole height set.
	<p> TIP – Ask the surveyor to bench and adjust their pole height to agree with the same benchmark that the machine has been benched on.</p>

7.1.3 Troubleshooting UTS guidance

The table below lists some of the error messages that may appear in the work screen and common error states during operation.

Operational State	Problem	Solution
Move Machine	Not enough information to calculate the machine heading.	Drive the machine in any direction until the message no longer displays.
UTS Out of Level	The tilt compensator on the UTS instrument is out of range.	<ol style="list-style-type: none"> 1. Stop the UTS instrument. 2. Repeat the position setup for the instrument using Trimble SCS900 or Siteworks, making sure that the tripod is secure and the instrument is level. 3. Start the UTS instrument from the UTS Management screen.
Target Lost. Searching...	The UTS instrument used for guidance has lost line of sight to the machine target and Auto Search is enabled.	<ol style="list-style-type: none"> 1. If required, tap Cancel to cancel the search. 2. Move the machine or remove any obstruction to the line of sight. 3. Start a search for the UTS instrument from the UTS Management screen. 4. Optionally, hold and point the UTS instrument at the target to regain the lock.
UTS - Low Battery xx% of battery remaining	This message appears briefly on screen, first when the UTS battery level is at 15%, and then when the UTS battery level reaches 5%.	<p>You can choose to carry on working or select another instrument from the UTS Management screen. Guidance is still provided.</p> <p>Check the remaining battery level of the UTS instrument in the UTS Management screen.</p>

7.2 Best Practices When Using Single-3D Guidance

The following best practices are recommended:

- Check and update blade wear regularly.
- Maintain the machine in good condition to remove the play in joints that is caused by excessive wear.
- Ensure that the system has an accurately calculated orientation by moving the machine when prompted to do so. If the machine direction is wrong, tap the direction

shortcut key to change it (press and hold the shortcut key to open the Direction of Travel screen). An accurately calculated orientation is required for accurate guidance.

- When using an electric mast, completely lower the mast extension during operation.

7.2.1 UTS

- Place the UTS on a tripod, free from vibrations caused by passing machinery or the wind.
- For best accuracy, place the UTS between 15 meters (50 feet) and 200 meters (650 feet), up to a maximum of 300 meters (1000 feet), from the MT900 target.
- Set up UTS instruments accurately using a minimum of three survey control points in a good geometric pattern.
- For UTS guidance, check blade tip elevation against an independent known elevation before starting work and remove any differences by benching.
- Ensure that the UTS has a continuous line of sight to the MT900 target. Check that the line of sight is maintained for all machine positions across the work area.

7.2.2 General procedures before a grading run

Perform the following procedures before any grading run:

- Bench the UTS and verify the accuracy of the system using a grade checker.
- If accuracy does not meet requirements, verify the cause before recalibrating the sensors.
- If using electric masts, ensure that the mast lean is less than $\pm 10^\circ$ off vertical.
- Avoid rotating or pitching the blade during a run.

Using Autos

In this chapter:

- ▶ Autos Setup - all machines
- ▶ Autos Optimization
- ▶ Best Practices when Using Autos

This chapter introduces the use of automatic controls.

8.1 Autos Setup - all machines

When you engage Autos the system automatically controls lift and tilt movement of the blade.

Note – Cat machines: This information applies to all supported Cat Next Gen dozers.

Note – If you are in Cross Slope mode, the system only controls tilt movement of the blade. You will need to manually control the lift.

Note – These instructions apply to both blade slope and cross slope systems. Use these instructions for either system configuration:

- *Blade slope systems measure - blade slope only*
- *Cross slope systems measure - blade slope, blade rotation and machine mainfall*







TIP – For information on how to get the most out of Autos, see 8.3 Best Practices when Using Autos.









TIP – When using Autos features, avoid connecting the Operator app device to the system via Wi-Fi. Ensure that you use a wired connection.

8.1.1 Autos status indicators

The Autos status indicators at the bottom corners of the work screen show you what state Autos are currently in. The Blade Lift status indicators are on the left-hand corner and the Blade Tilt status indicators are on the right-hand corner of the screen.

Lift and tilt status indicator	Status
 MANUAL	<i>Manual</i> Autos is not engaged.
MANUAL 	
D3-D7 machines and machines with a Trimble Valve Module	
 MANUAL	<i>Manual interlock</i> Autos cannot be engaged.
MANUAL 	Possible reason: The park brake is on.
 AUTO	<i>Autos ready</i> Autos is engaged, but is not activated. D6 & D7 - Possible reason: The blade has not latched to

Lift and tilt status indicator	Status
	grade. All machines - Possible reason: The blade is being manually controlled by moving the joystick.
All machines	
	<i>Autos engaged</i> Autos is engaged and activated with the blade inside the control range. In this state the system controls movement of the blade.
	
	<i>Autos not ready</i> Autos is engaged but cannot be activated so Autos is temporarily suspended. Possible reason: GNSS precision is outside tolerance, or the blade is off design.
	
D3 - D5 machines and machines with a Trimble Valve Module	
	<i>Autos interlock</i> Autos is engaged but the system has either:
	<ul style="list-style-type: none"> • Timed out of the Autos not ready state. • Detected a machine interlock condition, such as operator presence. <p>If the machine has Slope Assist or Blade Float and either of those screens are active while using Autos, the system considers this to be an interlock condition.</p> <p><i>Note – To change out of this state, press the auto switch to return to the Manual state.</i></p>

8.1.2 Engaging Autos - D3 - D5 and Trimble Valve Module machines



WARNING — The cutting edge may move without warning when Autos is engaged. These sudden movements could cause injury to anyone near the cutting edge, or damage to an unattended machine. Always put the system in Manual and engage the machine's park brake before you leave the machine, or when somebody is working near the cutting edge.

To use Autos:

1. Load a design or have a benched surface to guide to.
2. Make sure the machine's hydraulic oil is at its normal operating temperature.
3. Turn the throttle up to maximum revs. If equipped, turn off Eco-mode.
4. Position the blade within the control range.



TIP – Use the lightbars, cut/fills and buzzer to guide the blade.

5. Engage Autos: Press the auto switch as the cutting edge approaches the design elevation.

Note – Each press of the auto switch will cycle between Auto and Manual.

Cat D3-D4 machines joystick

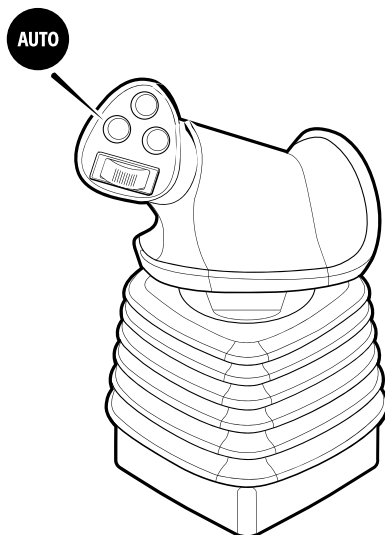

To switch Autos off and return to Manual, press the auto switch or you can temporarily over-ride Autos by moving the joystick while you are in the Autos control window. Be aware that while Autos is disengaged you can cut beneath the design. Sometimes you may purposefully want to cut below design, however if this is not the case make sure that you monitor your cut/fills and lightbars.

To re-engage Autos, press the auto switch again or if you temporarily over-rode Autos then return your joystick to the neutral position.

Cat D5 machines joystick

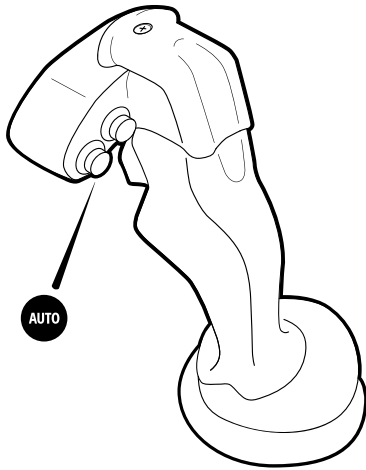

To switch Autos off and return to Manual, press the auto switch or you can temporarily over-ride Autos by moving the joystick while you are in the Autos control window. Be aware that while Autos is disengaged you can cut beneath the design. Sometimes you may purposefully want to cut below design, however if this is not the case make sure that you monitor your cut/fills and lightbars.

To re-engage Autos, press the auto switch again or if you temporarily over-ride Autos then return your joystick to the neutral position.

8.1.3 Engaging Autos - D6 - D7 machines



WARNING — The cutting edge may move without warning when Autos is engaged. These sudden movements could cause injury to anyone near the cutting edge, or damage to an unattended machine. Always put the system in Manual and engage the machine's park brake before you leave the machine, or when somebody is working near the cutting edge.

To use Autos:

1. Load a design or have a benched surface to guide to.
2. Make sure the machine's hydraulic oil is at its normal operating temperature.
3. Turn the throttle up to maximum revs. If equipped, turn off Eco-mode.
4. Position the blade within the control range.



TIP - Use the lightbars, cut/fills and buzzer to assist you to position the blade within the control range. The Control Range is also available as a text item.

5. Access the Autos Setup screen via the Work Settings menu.
6. In the Autos Setup screen, select the Autos mode you require and tap Apply.
 - Latch to Grade (default): the system controls the blade when either blade tip is on grade.
 - Snap to Grade: the system controls the blade when both blade tips are within the auto controls range limit.

Note – If you are using the AutoCarry feature in conjunction with Autos, the feature with the largest raise command or the smallest lower command takes control of the blade, with the exception that Autos (Grade Control) will not allow the blade to cut below design without a deliberate manual joystick command to over-ride Autos. See the Best Practices when using Autos guide for more information.

7. Exit to the work screen.
8. For Snap to Grade—Press the auto switch as the cutting edge approaches the design elevation to engage Autos.

Note – Each press of the auto switch will cycle between Auto and Manual.

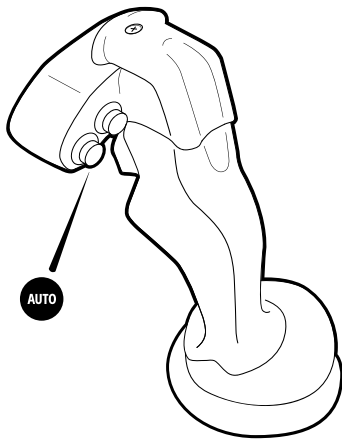

To switch off Autos and return to Manual, press the auto switch or you can temporarily over-ride Autos by moving the joystick while you are in the Autos control window. Be aware that while Autos is disengaged you can cut beneath the design. Sometimes you may purposefully want to cut below design, however if this is not the case make sure that you monitor your cut/fills and lightbars. To re-engage Autos, press the auto switch again or if you temporarily over-rode Autos then return your joystick to the neutral position.

9. For Latch to Grade—Drive the machine onto design and when either blade tip is on grade the system will go into the Autos Engaged state. You can temporarily over-ride Autos by moving the joystick. This will put the system into the Autos Ready state. Now put the joystick into neutral and move the joystick in the desired direction again to start driving the blade manually.

Select and Apply a Preset

You can select and apply the active preset via the Autos Setup or Autos Optimization screen. You can access these screens via the Work Settings menu. There is always at least one preset stored which is the Default preset set by your technician in the Web Interface. This cannot be edited or deleted.

Select the active preset that you require and tap Apply.

You can create, edit or delete a preset via the Autos Optimization screen. For more information, see 8.2 Autos Optimization.

8.1.4 Troubleshooting

The table below lists some of the error messages that may appear when you use Autos. You may need to enlist the help of your technician to resolve the error states.

Error Message	Possible cause(s)
Unable to Enter Autos. No Valve Calibration Available.	Suspect that the valve calibration has not been completed in the Web Interface.
Auto State Not Visible.	Suspect that other menus or apps are obscuring the Autos icon.

8.2 Autos Optimization



TIP – For information on how to use Autos, see *Autos Setup*.

8.2.1 Presets

Presets allow you to save Autos Optimization settings so that you can restore them later. This is useful when there is a change in application or material.

Select and Apply a Preset

You can select and apply the active preset via the Autos Setup or Autos Optimization screen. You can access these screens via the Work Settings menu. There is always at least one preset stored which is the Default preset set by your technician in the Web Interface. This cannot be edited or deleted.

Select the active preset that you require and tap Apply.

Add a new preset

Note – When you add a new preset the Autos Optimization sliders are set to their default values.

1. In the Autos Optimization screen, tap Create. The Add New Preset screen opens.
2. Tap inside the *Preset Name* field and enter a descriptive name for the preset.
3. Tap Apply. You are returned to the Autos Optimization screen.
4. In the Autos Optimization screen, use the Autos sliders or the arrows to increase (▲) or decrease (▼) the values. For more information, see the section on optimizing the Autos performance.
5. The preset changes to a customized or temporary state (as indicated by the * next to the preset name and the italicized text).
6. Tap Apply to save the preset in its customized state.

Note – All changes will be discarded if you select the original unmodified preset or a different preset. To save the customized preset permanently, tap Save As. See Save an edited preset with a new name.

Edit a preset

Note – If you try to switch to another preset while editing, the **Discard All Changes?** confirmation message appears. Any unsaved changes you made will be lost if you tap Yes.

1. In the Autos Optimization screen, select and apply a preset.
2. Use the Autos sliders or the arrows to increase (▲) or decrease (▼) any of the values.
Any edit you make to a preset puts it into a customized and temporary state (as indicated by the * next to the preset name and the italicized text).
3. To save the changes, tap Save As. The Save Preset As screen opens.
4. Turn on the Replace Existing slider. It will auto populate the Preset Name field with the name of the active preset. Tap Apply. You are returned to the Autos Optimization screen. The **Preset Overwritten** notification message appears.



TIP - To save the customized preset with a new name, see Save an edited preset with a new name.

Save an edited preset with a new name

Any active preset that is in a customized and temporary state (as indicated by the * next to the preset name and the italicized text) can be permanently saved as a new preset with a different name.

1. In the Autos Optimization screen, tap Save As. The Save Preset As screen opens.
2. Tap inside the *Preset Name* field and enter a descriptive name for the preset.
3. Tap Apply. You are returned to the Autos Optimization screen. The **Preset Saved Successfully** notification message appears.



TIP - If you turn on the Replace Existing slider, it will auto populate the Preset Name field with the name of the active preset. Tap Apply. You are returned to the Autos Optimization screen. The **Preset Overwritten** notification message appears.

Delete a preset

Note – You cannot delete the Default preset.

1. In the Autos Optimization screen, select a preset and tap the delete icon () on the right-hand side of the preset.
2. A **Delete** confirmation message appears.
3. Tap Yes to confirm the deletion.

8.2.2 Optimize the Autos performance

Note – Check that your technician has calibrated the valves before you try to adjust the values in the Autos Optimization screen. If hydraulic service work has been performed on the machine a new valve calibration may be required.

Note – For more detailed instructions, refer to the technician's Autos Optimization guide in the Web Interface.

You may need to adjust the Autos Optimization settings when, for example, you work with a different type of material (such as sand, dirt, or gravel). You may also need to re-adjust the Autos Optimization settings if you change the balance of your dozer, for example by adding rippers to the back. An indication that Autos Optimization adjustment may be needed is if the graded surface has either long slow or short choppy waves in it.

If there are waves in the graded surface adjusting the Autos Optimization settings may improve the performance of Autos. When optimizing you need to define what the upper and lower limits are, so that you can find the best performance. You need to tune past what you think is good, until it starts to get worse so that you can accurately determine when you reach best performance. This will require making multiple test passes.



TIP – As you cut a test pass, keep your ground speed constant and your material and blade load constant. Load the blade to between one-quarter to one-half of the blade.

The initial Autos Optimization should already have been performed by your technician, you should only need to refine it, for example, as material conditions change. Only make small

adjustments while tuning. If you need to make an adjustment of more than 10 units there may be a problem—contact your technician for assistance.

To optimize Autos:

Note – If you need to return to the default Autos settings, you can select *Default* from the *Preset* drop-down list in the *Autos Optimization* screen.

1. Make sure the machine's hydraulic oil is at its normal operating temperature.
2. Turn the throttle up to maximum revs. If your machine has Eco-mode, turn it off.
3. Using Autos, cut a test pass in the material you are working, so that you can judge the current performance of Autos.



TIP – As you cut a test pass, keep your ground speed constant and your material and blade load constant. Load the blade to between one-quarter to one-half of the blade.

4. To make any changes to the Autos settings, access the Autos Optimization screen via the Work Settings menu.
5. Move the slider(s) to increase or decrease the values. Change only one parameter at a time.



TIP – Initially, make adjustments of approximately 2 units at a time.

The options available are described in the following table.

Option	Description and examples
Raise/Lower Speed	<p>The Raise/Lower Speed controls the speed at which the blade reacts.</p> <p>To raise/lower the blade faster increase these values; to raise/lower the blade slower decrease these values.</p> <p>If the finished surface shows short choppy waves, decrease the values; for long rolling waves, increase the values.</p>

Option	Description and examples
	<p><i>Note – The initial valve tuning should already have been performed by your technician. Your technician will have found a value that results in the blade raising and lowering at approximately the same speed. Try to maintain the relationship between the Raise and Lower Speeds, for example, if the Raise Speed is set to 95 and the Lower Speed is set to 90 and you change the Raise Speed by 2 units (97) then to maintain the relationship you would set the Lower Speed to 92. In some cases, this relationship may need slight re-adjustment, depending on the type of material and speed.</i></p>
Tilt Speed	<p>Usually you do not need to adjust the tilt speed. However, if you do, adjust the tilt speed so that the system drives the blade to grade quickly, but does not overshoot grade.</p> <p>Increase the tilt speed if you want the blade to tilt faster. Decrease it, if you want the blade to tilt slower.</p>

6. Tap Apply.
 7. Cut another test pass and compare the results. Repeat the process, if necessary, until you get the results you desire. If you notice that the performance degrades, take a step back and readjust the setting by a smaller amount until you find the setting that provides peak performance.
- You may need to enlist the help of your technician. Further fine tuning and a precise check of the machine measure-up can be done via the Web Interface.

Additional advanced Autos Optimization settings

Your technician can enable additional advanced Autos Optimization settings via the Web Interface. The additional option available is Stability. Stability controls the speed that the blade stops at when it reaches design.

Increase stability if the blade is overshooting the design by more than 1 cm (0.4 inches). Decrease stability if the blade is slow or jerky to reach the design.

8.3 Best Practices when Using Autos

Note – These instructions apply to both blade slope and cross slope systems. Use these instructions for either system configuration:

- *Blade slope systems measure - blade slope only*
- *Cross slope systems measure - blade slope, blade rotation and machine mainfall*



TIP – When using Autos features, avoid connecting the Operator app device to the system via Wi-Fi. Ensure that you use a wired connection.

For the best results when using Autos, follow the practices outlined below.



WARNING — The cutting edge may move without warning when Autos is engaged. These sudden movements could cause injury to anyone near the cutting edge, or damage to an unattended machine. Always put the system in Manual and engage the machine's park brake before you leave the machine, or when somebody is working near the cutting edge.

8.3.1 Prepare the machine

Before you use Autos, your technician or installer should check that:

- The machine is in good operating condition.
- None of the cylinder connection points have excessive wear. If the cylinder connection points are loose it can cause movement in the blade and will affect the accuracy of the system.
- The pivot bearings are well lubricated and do not have excessive wear. If the pivot bearings are loose it can cause movement in the blade and will affect the accuracy of the system.
- The track tension is within manufacturer's specification, adjust as needed. If the track tension is too loose or too tight it will affect the performance of Autos.
- The measure-up and calibration of the machine is accurate. The surface you build cannot be better than the accuracy of these measurements and calibrations.
- Cat D5 and D6 machines only - A valve calibration has been performed.
- Cat D7 machines only - The Body Sensor check in the Web Interface is done every 1000 operating hours.

8.3.2 Best practices for operating dozers

Autos can be used in a variety of applications to increase productivity, from bulk earthmoving to finish grading.

Procedures to perform every time you use Autos

- Make sure the machine's hydraulic oil is at its normal operating temperature.
- Turn the throttle up to maximum revs. If your machine has Eco mode, turn it off.

The hydraulic pump should always have maximum power available to it, so the hydraulic system can respond to automatic commands as quickly as possible.

- Position the blade within the control range.



TIP – Use the lightbars, cut/fills and buzzer to assist you to position the blade within the control range. The Control Range is also available as a text item.

- Control the speed of the dozer through the gears. If your dozer has a setting that allows full engine speed even through de-acceleration then turn it on. This will give best performance when building the start pad and during the initial acceleration into the run.
- Due to the harmonics of undercarriage every dozer has a certain speed that produces optimal performance. Vary ground speed often to find this speed. Use this speed when making final passes.

Procedures to perform, as required

- Update the cutting edge length to account for the wear of the blade. If required, update the values in the Cutting Edge Length screen, accessed via the Edit button on the Blade Manager screen.

Note – The frequency at which you need to check the cutting edge length depends on factors such as the type of material you work with and the durability of the cutting edge.

- Replace the cutting edge if there is more than a 3 mm ($\frac{1}{8}$ inch) deviation.

The blade wear deviation can occur in different ways; it can arc from the center to the edges creating a downward bow, it can arch from the edges to the center creating an upward bow or from the center wearing at either end.

To check the deviation, do one of the following:

- Place the cutting edge on or slightly above a flat surface, such as concrete or pavement.
- Tie a string across the bottom of the cutting edge.

Compare the cutting edge to the surface or string. In each case, the straight edge of the blade should have less than 3 mm ($\frac{1}{8}$ inch) deviation. If the cutting edge does not meet this specification, replace it.

- Ask your technician to perform a new valve calibration when:
 - The ambient temperature is much lower or higher than when the last valve calibration was performed.
 - The hydraulic system has been serviced or modified.
- Check for machine wear points over time, and correct:
 - Track slop. Track bounce can degrade the performance of Autos.
 - Wear on the hydraulic ram connections. Check the lift ram and tilt ram connections.

- Ensure that very small hydraulic movements equals very small blade movements. If they do not, suspect wear in the hydraulic ram connections.
- Cat D7 machines only - Check the number of operating hours for the body sensor. Open the System Status page, tap Body Sensor and view the Hours since last Body Sensor Check. Let your technician know when the hours get close to 1000.

Operating practices that can improve performance

- To improve grading performance avoid using poor technique. Examples include:
 - Operating too fast for the task being carried out and the material being worked.
 - Cutting a rough surface at too high a speed. This can result in a rippled or wavy final surface.
 - Moving too much material. This can cause the machine to rock forward and overcut.
- Create a smooth starting pad.
The starting platform for your run is one of the most important things to get correct. Spend time building this and use Autos to assist you. Crawling backwards and forwards at a very low speed will allow the blade to stay accurately on grade. Back-blading can help keep the pad smooth.
- Use smooth acceleration.
When starting off from the pad, accelerate smoothly to grading speed. Make sure you pick up the material in the blade smoothly. Do not slam into a pile of gravel. Any disturbance at the start of the run will cause the dozer to oscillate and build several waves in the surface before it recovers.
- Use the correct blade load.
An empty blade is as bad as an overloaded blade. Keep the blade load to between one-quarter to one-half full.
With too much material in the blade, response is reduced as the blade must react against the material. Also it will spill out the sides and make general operation more difficult.
An empty blade is also bad as there is no dampening of the blade by the material. An empty blade is more likely to chatter or move up and down quickly.
Keeping one-quarter to one-half a blade load during the run will ensure that you can achieve optimum performance.
- Autos optimization.
You can improve the performance of Autos by adjusting the values in the Autos Optimization screen. For example, if the finished surface shows short choppy waves, decrease the raise/lower speed.
Another example of when you might need to adjust the Autos optimization values is when material conditions change:

- Type
- Density
- Moisture content

Note – For more information, see the Autos Optimization guide.

- Use the correct blade angle.

On machines with a rotating blade, a small amount of angle will improve the smoothness of the surface over a square blade. Move the tip of the blade back at least 150 mm (6 inches) to increase the stability of the dozer. More angle is better but will depend on how the material must be moved.

The job will largely dictate where material is moved from and to, and angle on the blade will side-cast the material into a windrow.

Take a final pass of 10 mm (½ inch) to cut it down to the final height using an angled blade, if possible.
- Making corrections.

If things go wrong, stop and back-blade, if required, to carry the blade load back. Back up a few more meters, and start again.

Operating practices when using Autos in conjunction with AutoCarry on Cat machines

On newer Cat machines, the AutoCarry feature and Autos (Grade Control) share the same Autos button on the joystick. If AutoCarry has been enabled in the integrated Cat machine display, pressing the auto switch on the joystick will engage or disengage both AutoCarry and Autos (Grade Control). The feature with the largest raise command or the smallest lower command takes control of the blade, with the exception that Autos (Grade Control) will not allow the blade to cut below design without a deliberate manual joystick command to over-ride Autos.

There are times during the dozer work cycle when you need to be aware of which system will have control of the blade and when it would be beneficial to over-ride or turn Autos off. This differs between the Snap to Grade and Latch to Grade auto modes.

The dozer cycle can be split into the following phases; Cut, Carry, Fill/Stack and Return. Each of these phases are discussed in the following sections.

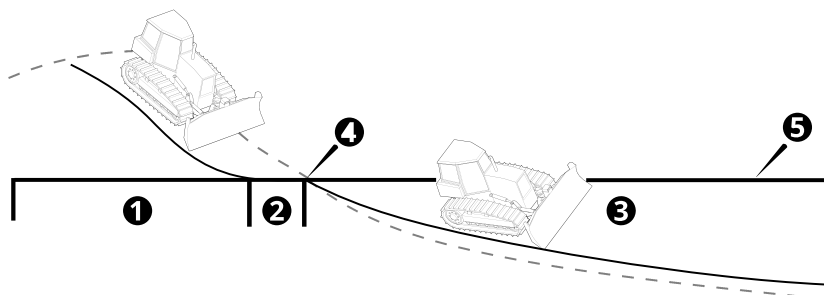

① Cut phase	② Carry phase	③ Fill phase
④ Breakthrough point	⑤ Design	

Latch to Grade

Latch to Grade is available on newer Cat machines. For information on how to enable Latch to Grade, see the *Autos Setup* guide.

The following table provides an overview of when to over-ride Autos, or turn Autos on and off during the dozer work cycle.

Dozer cycle phase	Autos On/Off/Over-ride
Cut	On
Carry	On
Breakthrough point	Temporarily over-ride Autos with joystick
Fill	On, AutoCarry will manage blade load
Return	Off at the breakthrough point

Cut phase

Turn Autos on as you load the blade with manual joystick commands, if a blade tip touches design then Autos will latch on. The latch will be broken if AutoCarry has the largest raise command and raises the blade to maintain forward drive; or if you make a deliberate joystick command (return the joystick to the neutral center position and then make a manual joystick raise or lower command).

Carry phase

Keep Autos on, AutoCarry will have control raising and lowering to achieve the target load factor unless a blade tip touches design. If a blade tip touches design then Autos will latch on.

Note – If AutoCarry tries to lower the blade causing a tip to touch design, Autos will take control and prevent the blade from cutting below design.

Breakthrough point and fill phase

You will need to visually monitor when the machine reaches the breakthrough point and transitions from the carry phase into the fill phase (where the existing ground slopes down away from design). As you reach this point and a blade tip touches design, Autos will latch on. To prevent this, you must temporarily over-ride Autos with the joystick (return the joystick to the neutral center position and then use manual lower commands until the

blade tip is below the design) to continue carrying the load down below design into the fill area.

AutoCarry is active and will continue to control the blade to achieve the target load factor while the load is carried down into the fill.

Note – When you start to spread the load you can raise the blade using the joystick - there is no need to turn Autos off with the auto switch.

Note – If you turn off Autos then AutoCarry will also turn off.

Return phase

Turn off Autos as you go into the return phase to prevent Autos latching to grade from below as the machine travels back through the breakthrough point.

Snap to Grade

Snap to Grade is available on newer Cat machines. For information on how to enable Snap to grade, see the *Autos Setup* guide.

Note – The Auto Control Range Limit timer which disables Autos after 1 minute while AutoCarry has control is not active.



TIP – Configure the Controls Range Limit text item to appear on the Text Ribbon on the Grade Control display.

The following table provides an overview of when to over-ride Autos, or turn Autos on and off during the dozer work cycle.

Dozer cycle phase	Autos On/Off/Over-ride
Cut	Off first, to load the blade. On, once enough load is acquired or as the blade gets close to design.
Carry	On.
Breakthrough point	On, over-ride Autos with joystick until you are below design and the Auto Control Range Limit warning is triggered (orange banner on the display).
Fill	On.
Return	Off at the breakthrough point.

Cut phase

Load the blade in the Manual control state. This is to prevent Snap to Grade driving the blade down to design when the blade tips enter the control range. This could cause track slip and AutoCarry to raise the blade, which could result in a hollow in the floor at the transition from cut to carry.

Turn Autos on when either the blade has acquired enough load or the blade is getting close to design.

Carry phase

Keep Autos on, AutoCarry will have control raising and lowering to achieve the target load factor unless both blade tips enter the control range, then Autos will snap to grade.

Note – If AutoCarry tries to lower the blade causing a tip to touch design, Autos will take control and prevent the blade from cutting below design.

Breakthrough point and fill phase

You will need to visually monitor when the machine reaches the breakthrough point and goes from the carry phase into the fill phase where the existing ground slopes down away from design. As you reach this point, the blade tips will enter the auto control range and will snap to grade (raise the blade back to design). You must temporarily over-ride Autos with the joystick (hold it forward and use manual lower commands until the blade tip is below the auto control range limit and the orange warning banner appears on the display) to breakthrough the design and continue carrying the load down into the fill area. AutoCarry will manage the blade load into the fill.

Note – If you misjudge and stop over-riding while still in the auto control range limit, then Autos will raise the blade back to design and the load will be lost.

Note – If you turn off Autos then AutoCarry will also be off.

Return phase

Turn off Autos as you go into the return phase to prevent Autos snapping to grade from below as the machine travels back through the breakthrough point.

Mapping

In this chapter:

- ▶ [Mapping](#)

This chapter introduces the use of mapping. Mapping provides a location-oriented record of machine activity and site information.

9.1 Mapping

Note – Mapping and the features mapping offers are configurable in the Web Interface by your technician. In addition, advanced mapping features may only be available if the correct license is installed. If mapping or a mapping feature is not available on your system, contact your technician or dealer.

Mapping data is the cutting edge or track elevation, recorded as the machine works.

You can also optionally:

- Display the cut/fill differences between the recorded map data and the guidance surface.
- Display an initial map generated from the cut/fill differences between a pre-mapped surface, called a ground surface, and the guidance surface.

For example, if the ground surface is based on a survey of the original site, then the initial map could enable you to move dirt around the site more efficiently.

Note – The ability to select a ground surface is a licensed feature. Contact your dealer for more information.

9.1.1 Using mapping

Mapping is available when you have an office or in-field design loaded.

The shortcut key

When you are in the work screen, you can use the shortcut key  to turn the display of cut/fill mapping data on and off.

You can also touch and hold the shortcut key to open the Cut/Fill Mapping screen.

Mapping rules

Active Body IMU systems

Mapping data is collected when the following conditions are met:

- When the cutting edge is within 100 mm (4 inches) of the track plane, blade mapping of the cutting edge starts. Blade mapping continues as long as the cutting edge remains within 150 mm (6 inches) of the track plane.

Note – 100 mm (4 inch) and 150 mm (6 inches) are the default values for starting and continuing mapping. These values may be changed by your technician.

OR

- Map data is calculated using the elevation of the tracks (track mapping).

Track Mapping - Active Body IMU systems only

When track mapping is enabled in the Web Interface, cut/fill mapping for the tracks displays on the work screen. You can use track mapping to map the cut/fill of an area by driving the machine over the area with the blade raised over 100 mm (4 inches) above the track plane.

When track mapping is enabled and the cutting edge is within 100 mm (4 inches) of the track plane, both track mapping and blade mapping display on the work screen. Track mapping may appear as a different cut/fill to the blade cut/fill.

Inactive Body IMU systems

Mapping data is collected when the following conditions are met:

- When Autos is engaged.
- OR*
- If the cutting edge of the blade is within 100 mm (4 inches) of the target surface, then mapping starts and map data is calculated using the elevation of the blade (blade mapping). Mapping continues as long as the cutting edge remains within 150 mm (6 inches) of the target surface.

Note – 100 mm (4 inch) and 150 mm (6 inches) are the default values for starting and continuing mapping. These values may be changed by your technician.

Note – Your technician can select whether blade mapping occurs when the machine is moving in any direction, or only when the machine is moving forward.

9.1.2 Start mapping with an empty map

To start mapping with an empty map:

1. From the Work Settings menu open the Cut/Fill Mapping screen, or touch and hold  in the shortcut bar.
2. Optionally, toggle Display Mapping Data on or off.
3. If available, from the Ground Surface drop down, select None.
4. Tap Apply.



ATTENTION – Changing the Ground Surface setting deletes any existing mapping data stored on the machine.

9.1.3 Start mapping with a pre-mapped surface

Note – The ability to select a ground surface is a licensed feature. Contact your dealer for more information.

To start mapping with a pre-mapped surface:

1. Transfer a ground surface .ttm file onto the machine. Either sync with Connected Community or import the ground surface file from a USB flash drive.
Note – If a Connected Community sync adds a new ground surface .ttm file to the current project, then a notification is displayed.
Note – To import a ground surface .ttm file from a USB flash drive, the ground surface file must be in the ProjectLibrary \ Projects \ [project name] \ OfficeData folder on your USB flash drive.
2. From the Work Settings menu open the Cut/Fill Mapping screen, or touch and hold  in the shortcut bar.
3. Optionally, toggle Display Mapping Data on or off.
4. From the Ground Surface drop down, select the ground surface file to load.
5. Tap Apply. If Display Mapping Data is on, a cut/fill map is generated showing the difference between:
 - The guidance surface of the currently loaded design; and
 - The ground surface

Note – If Lane Guidance is selected, then the cut/fill map generates using the lane guidance surface. In this case, cut/fill data is only displayed within 20 m (65 ft) of the machine.



ATTENTION – Changing the Ground Surface setting deletes any existing mapping data stored on the machine.

As you work, the pre-mapped ground surface elevations are overwritten by the measured elevations.

If you select a different design within the same project, the cut/fill map regenerates using the new design.

9.1.4 Downloading ground surface data from an online source

If your technician has enabled access, you can request the system to download the latest ground surface data in a .ttm file from an online source. This includes data from other machines on the site.

This option downloads data once when requested.

1. On the Cut/Fill Mapping screen, set the *Ground Surface* field to WorksOS download.
2. Tap Apply.

Downloading information for a large area can take a while.

Note – This feature requires an Advanced Mapping license. A machine can only download ground surface data for a compatible design.

9.1.5 Deleting map data

To delete any existing mapping data stored on the machine:

1. From the Work Settings menu open the Cut/Fill Mapping screen, or touch and hold  in the shortcut bar.
2. Tap Reset Map.

If a pre-mapped surface was initially loaded and Display Mapping Data is on, then the cut/fill map of the differences between the design surface and the pre-mapped surface is reset to its original state.

9.1.6 Inspecting a map



To view details of the mapping data on a plan view, touch-and-hold on an onscreen location where mapping data is recorded. Select Inspect Map from the context menu.

9.1.7 The work screen

Work screen items that affect the recording and display of mapping information are described in the following sections.

The guidance bar

The target icons relevant to Mapping are shown below:

Vertical elevation offset	Perpendicular elevation offset
	

Note – Either the vertical elevation offset **or** perpendicular elevation offset icon appears, depending on which offset type is in use.

Use the offset icons in the following ways:

- Tap to cycle through the configured offset memories.
- Touch and hold to access the respective offset configuration screens.

The guidance view

The guidance view displays the machine relative to the surface being worked. You can set up to three different views to display mapping data at once:

- Cross-section
- Profile
- Plan

Note – Mapping data is not visible in the 3D view.

Mapping data is displayed in the following way:

Color	Meaning
Shades of red	The shaded area is above the working surface elevation (cut).
Shades of green	The shaded area is within on-grade tolerance of the working surface elevation (on-grade).
Shades of blue	The shaded area is below the working surface elevation (fill).
Gray	Cut/fill values are being calculated and loaded.

System Settings

The System Settings icon is in the lower left-hand side of the work screen: 

Use System Settings to access and configure various functions, including (but not limited to):

- Grade Tolerance
- File Transfer

The shortcut bar

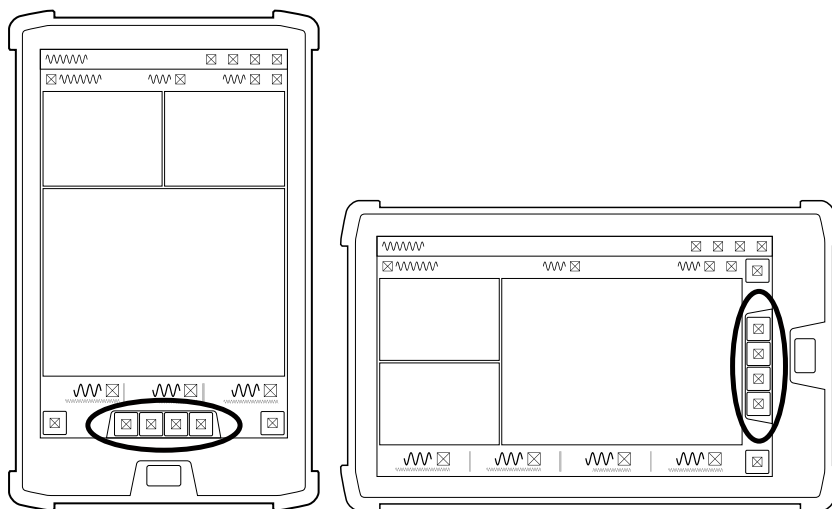

The shortcut bar enables you to easily perform frequently repeated tasks. The shortcut icon for mapping is: 

To display or hide mapping data, tap the mapping icon in the shortcut bar.

To open the Cut/Fill Mapping settings screen, touch and hold the mapping icon.

Work Settings menu

The Work Settings icon is in the lower right-hand side of the work screen: 

Use the Work Settings menu to access and configure those settings that change according to the requirements of each individual task, including (but not limited to):

- Cut/Fill Mapping
- Elevation Offset

9.1.8 For more information

See the following chapters:

- 1.5 Transferring Files
- 5.2 Using Elevation Offsets

9.1.9 Troubleshooting

The table below lists some of the error messages that may appear when you use mapping.

Error Message	Possible cause(s)
Unable To Load Cut/Fill Map	<ul style="list-style-type: none"> • Suspect a corruption of the mapping database, or a corruption of a ground surface file. • Otherwise, suspect a system state issue, and restart the system.

Avoidance Zones

In this chapter:

- ▶ [Avoidance Zones](#)

This chapter introduces the use of avoidance zones.

10.1 Avoidance Zones



WARNING — Entering an avoidance zone could cause personal injury or damage to the machine. Always be aware of nearby avoidance zones when operating a machine.



WARNING — You are responsible for observing safe operating practices. This product does not guarantee error-free avoidance zone guidance.

Avoidance zones indicate areas on a site that machines need to avoid. They appear as solid magenta shapes on the site plan and at the current machine elevation.

Avoidance zones display as horizontal boundaries that do not describe objects such as pipes or overhead wires.

Avoidance zones are available on machines with

- an applied project that has an avoidance file loaded into it
- 3D positioning sources only



Avoidance zone files are added to project files by the office or your technician.

Projects must be applied and include an avoidance zone file for the avoidance zones to display.

10.1.1 Avoidance zone icons

Applied projects that have avoidance zones (supplied by the office) can display the following icons:

Note – You can continue working when any of these icons display. These icons are for information only.

Icon	Meaning	Action
	Project includes an avoidance file	Continue working
	Avoidance file cannot be loaded Avoidance file has too many edges	Continue working and notify your technician



The avoidance file requires a 3D positioning source
 Some machine measurements are not configured

Continue working and notify your technician

10.1.2 The work screen

Applied projects that have avoidance zones (supplied by the office) can display the following border colors on the work screen:

Indicators	State	Machine proximity to zone
Blue border	Zone detected	The machine is approaching the avoidance zone but is still outside the warning perimeter.
Orange border Audible beep	Zone warning distance	The machine is within the warning perimeter of 8 m minimum, configurable in the Web Interface.
Magenta border Continuous audible beep	Zone breached	The machine is in the avoidance zone.

Note – When a machine breaches an avoidance zone, full guidance continues.

10.1.3 Machine boundary

The machine boundary is the magenta outline around the machine.

To show or hide the machine boundary outline, use the Machine Boundary toggle on the Overlays screen.

10.1.4 Troubleshooting

The table below lists an error message that may appear when working with avoidance zones.

Error Message	Possible cause(s)	Action
Avoidance Zone Proximity and Guidance Lost	Machine orientation is unknown.	Identify the avoidance zone on the site and move or rotate the machine away from the avoidance zone.

A

Remote Switch and Joystick Configuration on other machine models

In this chapter:

- ▶ Remote Switch Configuration for machines with a Trimble Valve Module
- ▶ Remote Switch Configuration for machines with steering control
- ▶ Joystick Configuration for Cat D3-D4 machines
- ▶ Joystick and Remote Switch Configuration for Komatsu machines

This section describes how joystick switches and remote switches integrate with the system allowing you to perform common features such as Autos.

Note – For Cat D5–D6 machines, see 1.2 Joystick Configuration for Cat D5–D7 machines.

A.1 Remote Switch Configuration for machines with a Trimble Valve Module

You can use the remote switch to perform common tasks while keeping your hands close to the machine controls. The remote switch only functions when you are in the work screen.

The vertical offset remote switch lets you:

- Engage Autos (❶).
Each press of the auto switch will cycle between Auto and Manual.
- Increase (❷) or decrease (❸) the elevation offset.

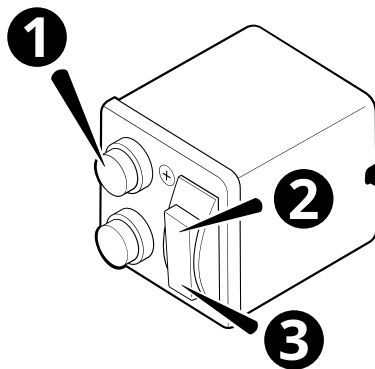

❶ Auto switch.

❷ Increment elevation offset switch.

❸ Decrement elevation offset switch.

A.2 Remote Switch Configuration for machines with steering control

You can use the remote switch to perform common tasks while keeping your hands close to the machine controls. The remote switch only functions when you are in the work screen.

A.2.1 Vertical offset remote switch

The vertical offset remote switch lets you:

- Engage Autos (❶).
Each press of the auto switch will cycle between Auto and Manual.
- Increase (❷) or decrease (❸) the elevation offset.

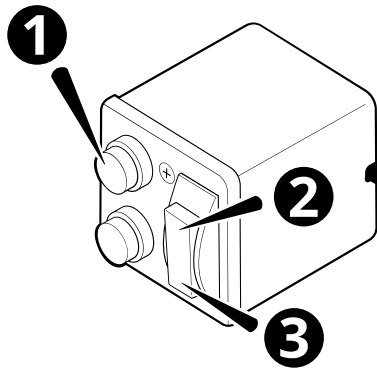

-
- | | |
|----------------|--------------------------------------|
| ❶ Auto switch. | ❷ Increment elevation offset switch. |
|----------------|--------------------------------------|
-
- | | |
|--------------------------------------|--|
| ❸ Decrement elevation offset switch. | |
|--------------------------------------|--|
-

A.2.2 Horizontal offset remote switch

The horizontal offset remote switch lets you:

- increment (❷) or decrement (❶) the Pass Shift count
- increment (❹) or decrement (❸) the horizontal offset

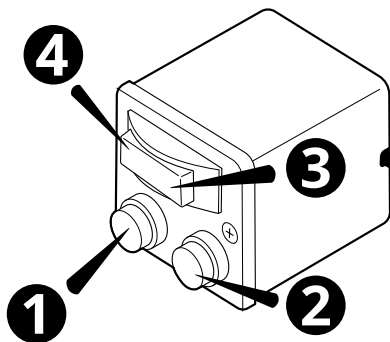

-
- | | |
|--------------------------------------|--------------------------------------|
| ❶ Decrement Pass Shift count switch. | ❷ Increment Pass Shift count switch. |
|--------------------------------------|--------------------------------------|
-
- | | |
|---|------------------------------------|
| ❸ Increment Horizontal Distance D switch. | ❹ Decrement Horizontal Distance D. |
|---|------------------------------------|
-

A.3 Joystick Configuration for Cat D3-D4 machines

You can use certain switches on the right joystick to perform common tasks while keeping your hands close to the machine controls. The joystick switches only function when you are in the work screen.

The joystick switches let you:

- Engage Autos.
Each press of the auto switch will cycle between Auto and Manual.
- Increase or decrease the elevation offset.

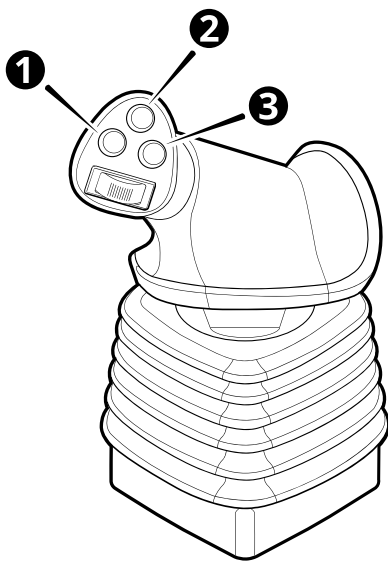

❶ Auto switch.

❷ Increment elevation offset switch.

❸ Decrement elevation offset switch.

A.4 Joystick and Remote Switch Configuration for Komatsu machines

This information applies to Komatsu D39–24, D51–24, D61–24 series machines only.

Use the blade joystick together with the remote switch to perform common tasks while keeping your hands close to the machine controls. The joystick switch and remote switch function only when you are in the work screen.

A.4.1 Joystick

You can engage autos using the auto switch on the blade joystick. Press the auto switch to change between Auto and Manual.

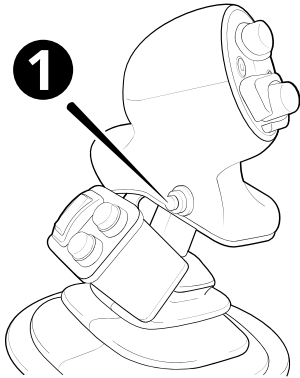

- 1 Auto switch.
-

A.4.2 Remote Switch

You can use the remote switch to increase or decrease the elevation offset.

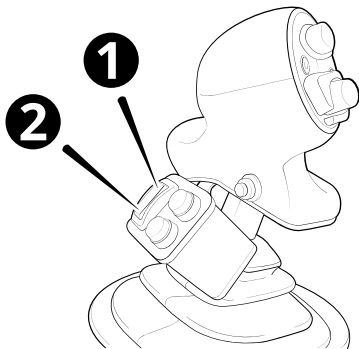

- 1 Decrement elevation offset switch.
 - 2 Increment elevation offset switch.
-

B

Legal and Regulatory

In this chapter:

- ▶ END USER LICENSE AGREEMENT
- ▶ Copyright Information
- ▶ Compliance notices
- ▶ Safety information

B.1 END USER LICENSE AGREEMENT

IMPORTANT, READ CAREFULLY. THIS END USER LICENSE AGREEMENT ("AGREEMENT") IS A LEGAL AGREEMENT BETWEEN YOU AND TRIMBLE INC. ("Trimble") and applies to the computer software provided by Trimble with Earthworks (the "Product") purchased by you (whether built into hardware circuitry as firmware, embedded in flash memory or a PCMCIA card, or stored on magnetic or other media), or provided as a stand-alone computer software product, and includes any accompanying printed materials and any "online" or electronic documentation ("Software"). The Software also includes any software, (including, without limitation, upgrades and updates) relating to the Product that is furnished by Trimble or its dealers (including, without limitation, Trimble software downloaded from Trimble's or its dealers' website(s)) unless accompanied by different license terms and conditions that will govern its use. BY CLICKING "YES" OR "I ACCEPT" IN THE ACCEPTANCE BOX, OR BY INSTALLING, COPYING OR OTHERWISE USING THE SOFTWARE, YOU AGREE TO BE BOUND BY THE TERMS OF THIS AGREEMENT. IF YOU ARE ENTERING INTO THIS AGREEMENT ON BEHALF OF A COMPANY OR OTHER LEGAL ENTITY, YOU REPRESENT THAT YOU ARE AUTHORIZED TO BIND THAT COMPANY OR LEGAL ENTITY TO THIS AGREEMENT. IF YOU DO NOT HAVE SUCH AUTHORITY OR ARE UNWILLING OR UNABLE TO BE BOUND BY THIS AGREEMENT, DO NOT CLICK "I ACCEPT" AND DO NOT ACCESS OR USE THE PRODUCT OR SOFTWARE. IF YOU DO NOT AGREE TO THE TERMS OF THIS AGREEMENT, DO NOT USE THE PRODUCT OR THE SOFTWARE. INSTEAD PROMPTLY RETURN THE UNUSED PRODUCT OR SOFTWARE TO THE PLACE FROM WHICH YOU OBTAINED THEM FOR A FULL REFUND. This Software is protected by copyright laws and international copyright treaties, as well as other intellectual property laws and treaties. The software is licensed, not sold.

1 SOFTWARE PRODUCT LICENSE

1.1 – License Grant. Subject to this Agreement, Trimble grants you a limited, non-exclusive, non-sublicensable right to use one (1) copy of the Software in a machine-readable form on the Product. Such use is limited to use with the Product for which it was intended and into which it was embedded. You may use the installation Software from a computer solely to download the Software to one Product. In no event shall the installation Software be used to download the Software onto more than one Product without securing a separate license. A license for the Software may not be shared or used concurrently on different computers or Products.

1.2 - Other Rights and Limitations.

(1) You may not copy, modify, make derivative works of, rent, lease, sell, distribute or transfer the Software, in whole or in part, except as otherwise expressly authorized under this Agreement, and you agree to use all commercially reasonable efforts to prevent its unauthorized use and disclosure.

(2) The Software contains valuable trade secrets proprietary to Trimble and its licensors. To the extent permitted by relevant law, you shall not, nor allow any third party to copy, decompile, disassemble or otherwise reverse engineer the Software, or attempt to do so,

provided, however, that to the extent any applicable mandatory laws (such as, for example, national laws implementing EC Directive 91/250 on the Legal Protection of Computer Programs) give you the right to perform any of the aforementioned activities without Trimble's consent in order to gain certain information about the Software for purposes specified in the respective statutes (i.e., interoperability), you hereby agree that, before exercising any such rights, you shall first request such information from Trimble in writing detailing the purpose for which you need the information. Only if and after Trimble, at its sole discretion, partly or completely denies your request, may you exercise such statutory rights.

(3) This Software is licensed as a single product. You may not separate its component parts for use on more than one Product.

(4) You may not rent, lease, or lend, the Software separate from the Product for which it was intended.

(5) No service bureau work, multiple-user license or time-sharing arrangement is permitted. For purposes of this Agreement "service bureau work" shall be deemed to include, without limitation, use of the Software to process or to generate output data for the benefit of, or for purposes of rendering services to any third party over the Internet or other communications network.

(6) You may permanently transfer all of your rights under this Agreement only as part of a permanent sale or transfer of the Product for which it was intended, provided you retain no copies, you transfer all of the Software (including all component parts, the media and printed materials, any upgrades, and this Agreement) and the recipient agrees to the terms of this Agreement, if the Software portion is an upgrade, any transfer must include all prior versions of the Software.

(7) You acknowledge that the Software and underlying technology may be subject to the export administration regulations of the United States Government relating to the export of technical data and products. This Agreement is subject to, and you agree to comply with, any laws, regulations, orders or other restrictions on the export of the Software from the United States which may be imposed by the United States Government or agencies thereof.

(8) At the request of Trimble, you agree to cooperate with Trimble to track the number of Products using Software at your site(s) to ensure compliance with the license grant and installation restrictions in this Agreement.

(9) Notwithstanding anything to the contrary in this Agreement, any Open Source Software that may be included as a part of the software package shall not constitute a portion of the Software as defined in this Agreement and is not licensed under the terms of this Agreement, but instead is subject to the terms of the applicable Open Source Software license. If required, Trimble has provided the license or notice statement for the applicable Open Source Software and such license or notice statement is accessible through the user interface for the Product. Unless otherwise required pursuant to the terms of an Open Source Software license, Trimble grants you no right to receive source code to the Open

Source Software; however, in some cases rights and access to source code may be available to you directly from the licensors. If you are entitled to receive the source code from Trimble for any Open Source Software included with the software package, you may obtain the source code at no charge by written request to Trimble at 5475 Kellenburger Rd., Dayton, Ohio 45424 USA, Attn: Earthworks Products Manager. You must agree to the terms of the applicable Open Source Software license, or you may not use the subject Open Source Software.

For purposes of this Agreement, "Open Source Software" means those software programs or libraries that are identified in the software documentation, read me and/or about files as being subject to any open source software license, and all modifications, derivative works and executables based on or derived from such software programs or libraries, if such modifications, derivative works and/or executables are also subject to the applicable open source software license by its terms.

(10) Use of both the Product and Software is subject to the terms of user manuals, technical manuals and any other materials provided by Trimble, or their licensors and/or suppliers, in printed, electronic or other form, that describe the installation, operation, use or technical specifications of the Product and/or Software (the "Documentation"). Without limiting the generality of the foregoing, the Documentation shall include the installation manual (a copy of which is viewable at [<https://community.trimble.com/community/partners/cec>]). The Documentation and the terms in it are hereby incorporated into this Agreement by reference. By installing and/or using the Product or Software, you hereby certify that you have reviewed the Documentation, have received the necessary notice of the terms contained in it, and agree to be bound by it.

1.3 – Termination. You may terminate this Agreement by ceasing all use of the Software. Without prejudice as to any other rights, Trimble may terminate this Agreement without notice if you fail to comply with the terms and conditions of this Agreement. In either event, you must destroy all copies of the Software and all of its component parts, and provide an affidavit to Trimble stating that you have done the same.

1.4 – Copyright. All title and copyrights in and to the Software (including but not limited to any images, photographs, animations, video, audio, music, and text incorporated into the Software), the accompanying printed materials, and any copies of the Software are owned by Trimble and its licensors. You shall not remove, cover or alter any of Trimble's patent, copyright or trademark notices placed upon, embedded in or displayed by the Software or on its packaging and related materials. You may, however, either (1) make one copy of the Software solely for backup or archival purposes, or (2) install the Software on a single computer provided you keep the original solely for backup or archival purposes. You may not copy the accompanying printed materials.

1.5 – U.S. Government Restricted Rights. Use, duplication, or disclosure by the United States Government is subject to restrictions as set forth in this Agreement, and as provided in DFARS 227.7202-1(a) and 227.7202-3(a) (1995), DFARS 252.227-7013(c)(1)(ii) (OCT 1988), FAR 12.212(a) (1995), FAR 52.227-19, or FAR 52.227-14(alt III), as applicable.

2 LIMITED WARRANTY

2.1 - Limited Warranty. Trimble warrants that the Software will perform substantially in accordance with the accompanying written materials for a period of one (1) year from the date of receipt. This limited warranty gives you specific legal rights, you may have others, which vary from state/jurisdiction to state/jurisdiction.

2.2 - Customer Remedies. Trimble 's and its licensors' entire liability, and your sole remedy, with respect to the Software shall be either, at Trimble 's option, (a) repair or replacement of the Software, or (b) return of the license fee paid for any Software that does not meet Trimble 's limited warranty. This limited warranty is void if failure of the Software has resulted from (1) accident, abuse, or misapplication; (2) alteration or modification of the Software without Trimble's prior written authorization; (3) interaction with software or hardware not supplied by Trimble; (4) improper, inadequate or unauthorized installation, maintenance, or storage of the Software or Product; or (5) if you violate the terms of this Agreement. Any replacement Software will be warranted for the remainder of the original warranty period or thirty (30) days, whichever is longer.

2.3 – NO OTHER WARRANTIES. TO THE MAXIMUM EXTENT PERMITTED BY APPLICABLE LAW, TRIMBLE AND ITS LICENSORS DISCLAIM ALL OTHER WARRANTIES AND CONDITIONS, EITHER EXPRESS OR IMPLIED, INCLUDING BUT NOT LIMITED TO, IMPLIED WARRANTIES AND CONDITIONS OF MERCHANTABILITY AND FITNESS FOR A PARTICULAR PURPOSE, TITLE, AND NONINFRINGEMENT WITH REGARD TO THE SOFTWARE AND THE PROVISION OF OR FAILURE TO PROVIDE SUPPORT SERVICES. THE ABOVE LIMITED WARRANTY DOES NOT APPLY TO ERROR CORRECTIONS, UPDATES OR UPGRADES OF THE SOFTWARE AFTER EXPIRATION OF THE LIMITED WARRANTY PERIOD, WHICH ARE PROVIDED “AS IS” AND WITHOUT WARRANTY. BECAUSE THE SOFTWARE IS INHERENTLY COMPLEX AND MAY NOT BE COMPLETELY FREE OF NONCONFORMITIES, DEFECTS OR ERRORS, YOU ARE ADVISED TO VERIFY YOUR WORK. TRIMBLE DOES NOT WARRANT THE RESULTS OBTAINED THROUGH USE OF THE SOFTWARE, OR THAT THE SOFTWARE WILL OPERATE ERROR FREE OR UNINTERRUPTED, WILL MEET YOUR NEEDS OR EXPECTATIONS, OR THAT ALL NONCONFORMITIES CAN OR WILL BE CORRECTED. TO THE EXTENT ALLOWED BY APPLICABLE LAW, IMPLIED WARRANTIES AND CONDITIONS ON THE SOFTWARE ARE LIMITED TO ONE (1) YEAR. YOU MAY HAVE OTHER LEGAL RIGHTS WHICH VARY FROM STATE/JURISDICTION TO STATE/JURISDICTION.

2.4 – LIMITATION OF LIABILITY. TRIMBLE'S ENTIRE LIABILITY UNDER ANY PROVISION OF THIS AGREEMENT SHALL BE LIMITED TO THE GREATER OF THE AMOUNT PAID BY YOU FOR THE SOFTWARE LICENSE OR U.S. \$25.00. TO THE MAXIMUM EXTENT PERMITTED BY APPLICABLE LAW, IN NO EVENT SHALL TRIMBLE OR ITS LICENSORS BE LIABLE FOR ANY SPECIAL, INCIDENTAL, INDIRECT OR CONSEQUENTIAL DAMAGES WHATSOEVER (INCLUDING, WITHOUT LIMITATION, DAMAGES FOR LOSS OF BUSINESS PROFITS, BUSINESS INTERRUPTION, LOSS OF BUSINESS INFORMATION, OR ANY OTHER PECUNIARY LOSS) ARISING OUT OF THE USE OR INABILITY TO USE THE SOFTWARE, OR THE PROVISION OF OR FAILURE TO PROVIDE SUPPORT SERVICES, EVEN IF TRIMBLE HAS BEEN ADVISED OF THE POSSIBILITY OF SUCH DAMAGES. BECAUSE SOME STATES AND JURISDICTIONS DO

NOT ALLOW THE EXCLUSION OR LIMITATION OF LIABILITY FOR CONSEQUENTIAL OR INCIDENTAL DAMAGES, THE ABOVE LIMITATION MAY NOT APPLY TO YOU. THE LIMITATIONS SET FORTH IN SECTION 2.4 SHALL APPLY EVEN IF THE LICENSEE'S REMEDIES UNDER THIS AGREEMENT FAIL OF THEIR ESSENTIAL PURPOSE

3 INFORMATION PROVIDED BY YOU FOR 'CONNECTED' FEATURES

The Software is designed to enable certain connected features, such as virtual reference station ("VRS") and Internet base station service ("IBSS") corrections, file sync (for design files, user preferences, Product firmware updates, etc.), 3D productivity services, and connected site services provided by others ("Connected Services"). Please refer to the Software documentation for additional information about Connected Services supported by the Software. You must separately obtain the right to access and use Connected Services, e.g., by maintaining a current subscription for the relevant services. To enable Connected Services, the Software may collect and/or receive data and information (the "Connected Information") relating to your Product and the equipment on which your Product is installed (your "Equipment"), including without limitation:

- Geolocation and 3D position
- Status (including configuration and operation)
- Equipment progress and activity
- VRS and IBSS correction information
- File sync and GNSS data
- Operator Key

The Connected Information may be transferred to your Connected Services providers through the networking and telematics systems installed on your Equipment (whether utilizing cellular, satellite, local area networks, ethernet or other similar systems, the "Telematics System") or manual file transfer (e.g., USB). The actual Connected Information collected and received will vary based on, among other things, the configuration of your Product and Equipment (including your Telematics Systems) and the related Connected Services that you separately elect to access and use. Please carefully review any agreements and documentation relating to such Connected Services to understand how the Connected Service provider may store and use the Connected Information.

In addition, Trimble or its affiliated companies may collect, store and receive data and information ("User Information") relating to your use of the Software, Product and Equipment, including without limitation:

- Device/Company Identity Data includes machine ID, machine sensor configuration, and software configuration
- Location includes Global Navigation Satellite System and beacon-based location
- Analytics Data includes Software versions, display model, stack trace system configuration, current design, features in use, time in each screen, button pushes, and Software bug and crash reports.

The actual User Information collected and received will vary based on, among other things, the configuration of your Product and Equipment and the related product(s) that you separately elect to access and use. You acknowledge and agree that Trimble or its affiliated companies may, directly or indirectly through the services of third parties, use User Information for its internal business purposes, including but not limited to: (i) making the Software and Products available and providing services to you; (ii) improving the performance of the Software and Products, researching and developing updates and other products and services, and analyzing adoption and usage of the Software and Products; and (iii) verifying your compliance with the terms of this Agreement and enforcing Trimble's rights, including all intellectual property rights in and to the Software and the Product(s). In order to provide you with the full range of benefits made possible by the Product(s) and our services, and in connection with the uses described above, Trimble may share the User Information with its affiliated companies. The affiliated companies may use the User Information for their own internal purposes in a manner consistent with the uses described above. Trimble and its affiliated companies may also disclose User Information if we have a good faith belief that (1) the disclosure is necessary or useful to our provision of services; (2) the disclosure is necessary to protect our rights, interests, or property; (3) the disclosure is necessary or useful to protect your safety or the safety of others, to investigate fraud, or to respond to a government request; (4) the disclosure is required by law, such as to comply with a subpoena, search warrant, court order, or similar legal or administrative process; or (5) Trimble or its affiliated company is or will be purchased or otherwise acquired, in which User Information will likely be among the assets transferred. Trimble and its affiliated companies and third parties acting on Trimble's or its affiliate's behalf may analyze User Information to analyze and create performance metrics, collect and evaluate other information relating to the Software and Product(s), and track anonymized and technical information to improve the Software and Product(s) ("Machine Performance Data"). Any information Trimble or its affiliated companies track in this manner is anonymous and limited to usage and volume statistics. Trimble and its affiliated companies may make the Machine Performance Data commercially available to third parties to the extent that it is aggregated or otherwise de-identified so that it cannot be used to identify you. By accepting this Agreement, you acknowledge and agree to the collection and use of the Connected Information, User Information and Machine Performance Data as provided above.

The Software may also automatically provide Software bug and crash reports via your Equipment's Telematics Systems to Trimble or its vendors for purposes of maintaining, supporting, or improving the Software.

You may incur additional charges for the transfer of Connected Information, User Information and Machine Performance Data, or Software bug and crash reports by your telecommunications service providers or your Connected Services providers, as applicable.

4 GENERAL

4.1 – This Agreement shall be governed by the laws of the State of California and applicable United States Federal law without reference to "conflict of laws" principles or provisions. The United Nations Convention on Contracts for the International Sale of Goods will not

apply to this Agreement. Jurisdiction and venue of any dispute or court action arising from or related to this Agreement or the Software shall lie exclusively in or be transferred to the courts located in Santa Clara County, California, and/or the United States District Courts for California. You hereby consent and agree not to contest, such jurisdiction, venue and governing law.

4.2 - Notwithstanding Section 4.1, if you acquired the Product in Canada, this Agreement is governed by the laws of the Province of Ontario, Canada. In such case each of the parties to this Agreement irrevocably attorns to the jurisdiction of the courts of the Province of Ontario and further agrees to commence any litigation that may arise under this Agreement in the courts located in the Judicial District of York, Province of Ontario.

4.3 - Official Language. The official language of this Agreement and of any documents relating thereto is English. For purposes of interpretation, or in the event of a conflict between English and versions of this Agreement or related documents in any other language, the English language version shall be controlling.

4.4 - Trimble reserves all rights not expressly granted by this Agreement.

© 2021, Trimble Inc. All Rights Reserved.

B.2 Copyright Information

Copyright© 2017, Trimble Inc. All rights reserved.

Trimble and the Globe & Triangle logo are trademarks of Trimble Inc., registered in the United States and in other countries.

CMR and CMR+ are trademarks of Trimble Inc.

Android is a trademark of Google Inc.

Wi-Fi, WPA and WPA2 are trademarks of the Wi-Fi Alliance, registered in the United States and other countries. Developed under a License of the European Union and the European Space Agency.

The Bluetooth word mark and logos are owned by the Bluetooth SIG, Inc. and any use of such marks by Trimble Inc. is under license.

B.3 Compliance notices

B.3.1 US FCC regulations

The following statement applies to these devices:

- EC520 electronic control module (FCC ID: K7T-WIFIHU2S and FCC ID: TLZ-NM230NF)
- TD520 display (FCC ID: TLZ-NM230NF)
- GS520 grade sensor

- AA510 audible alarm
- CI510 CAN interface

Note: This equipment has been tested and found to comply with the limits for a Class  B digital device, pursuant to part 15 of the FCC Rules. These limits are designed to provide reasonable protection against harmful interference in a residential installation. This equipment generates, uses and can radiate radio frequency energy and, if not installed and used in accordance with the instructions, may cause harmful interference to radio communications. However, there is no guarantee that interference will not occur in a particular installation. If this equipment does cause harmful interference to radio or television reception, which can be determined by turning the equipment off and on, the user is encouraged to try to correct the interference by one or more of the following measures:

- Reorient or relocate the receiving antenna.
- Increase the separation between the equipment and receiver.
- Connect the equipment into an outlet on a circuit different from that to which the receiver is connected.
- Consult the dealer or an experienced radio/TV technician for help.

B.3.2 Canadian license-exempt RSS standards

The following statement applies to these devices:

- EC520 electronic control module (IC: 2377A- WIFIHU2S and IC: 6100A- NM230NF)
- TD520 display (IC: 6100A- NM230NF)
- GS520 grade sensor
- AA510 audible alarm
- CI510 CAN interface

CAN ICES-3 (B)/NMB-3(B)

This device complies with Industry Canada license-exempt RSS standard(s). Operation is subject to the following two conditions:

1. This device may not cause interference, and;
2. This device must accept any interference, including interference that may cause undesired operation of the device.

Cet appareil est conforme avec Industrie Canada RSS standard exempts de licence (s). Son fonctionnement est soumis aux deux conditions suivantes:

1. Cet appareil ne peut pas provoquer d'interférences; et
2. Cet appareil doit accepter toute interférence, y compris les interférences pouvant entraîner un mauvais fonctionnement de la appareil.

B.3.3 European Union CE compliance

The following statement applies to these devices:



- EC520 electronic control module
- TD520 display
- GS520 grade sensor
- AA510 audible alarm
- CI510 CAN interface
- VM510 valve module

These devices are compliant with the following Directives and standards

- Machinery 2006/42/EC
- RoHS 2015/863/EU
- ISO 13766:2006
- ISO 13309:2010

The EC520 electronic control module and the TD520 display are also compliant with the following additional Directives and standards:

- Radio Equipment Directive 24/53/EU
- IETSI EN 300-328 V2.1.1
- ETSI EN 301-489-1 V2.1.0
- ETSI EN 301-489-17 V3.1.1

B.3.4 European Union recycling compliance

These products comply with the WEEE Directive 2012/19/EU. For recycling in Europe call:



+31 479 53 24 30

To request instructions by writing:

Trimble Europe BV

C/O Menlo Worldwide Logistics

Meerheide 45

5521 CZ Eersel, NL

B.3.5 Australian and New Zealand AS/NZS 55022 compliance

AS/NZS 55022 compliance applies to these devices:

- EC520 electronic control module
- TD520 display
- GS520 grade sensor
- AA510 audible alarm
- CI510 CAN interface



B.3.6 Japan Radio Type Approval

Construction Design Certificates apply to these devices:

- EC520 electronic control module (208-160089, R - 201-16379 and T- D 160 253 201)
- TD520 display (R - 201-16379 and T- D 160 253 201)



B.3.7 RoHS Statement

This device conforms to RoHS (Reduction Of Hazardous Sub-stances) European Union regulations that set maximum concentration limits on hazardous materials used in electrical and electronic equipment.



CAUTION: RISK OF EXPLOSION IF BATTERY IS DISPOSED OF INCORRECTLY. DISPOSE OF THE DEVICE AND THE BATTERY ACCORDING TO INSTRUCTIONS FOR ELECTRONIC WASTE.

B.3.8 Taiwan

低功率電波輻射性電機管理辦法

第十二條：經型式認證合格之低功率射頻電機，非經許可，公司、商號或使用者均不得擅自變更頻率、加大功率或變更原設計之特性及功能。

第十四條：低功率射頻電機之使用不得影響飛航安全及干擾合法通信；經發現有干擾現象時，應立即停用，並改善至無干擾時方得繼續使用。低功率射頻電機需忍受合法通信或工業、科學及醫療用電波輻射性電機設備之干擾。

SAR 標準值 2.0W/Kg, 送測產品實測值為 0.545w/Kg

B.4 Safety information

Most accidents that involve product operation, maintenance and repair are caused by failure to observe basic safety rules or precautions. An accident can often be avoided by recognizing potentially hazardous situations before an accident occurs. A person must be alert to potential hazards. This person should also have the necessary training, skills and tools to perform these functions properly.

Improper operation, lubrication, maintenance or repair of this product can be dangerous and could result in injury or death.

Do not operate or perform any lubrication, maintenance or repair on this product, until you have read and understood the operation, lubrication, maintenance and repair information.

Safety precautions and warnings are provided in this manual and on the product. If these hazard warnings are not heeded, bodily injury or death could occur to you or to other persons.

The hazards are identified by the "Safety Alert Symbol" and followed by a "Signal Word" such as "DANGER", "WARNING" or "CAUTION". The Safety Alert "WARNING" label is shown below.



WARNING — This alert warns of a potential hazard which, if not avoided, can cause severe injury.

The meaning of this safety alert symbol is as follows:

Attention! Become Alert! Your Safety is Involved.

The message that appears under the warning explains the hazard and can be either written or pictorially presented.

Operations that may cause product damage are identified by "NOTICE" labels on the product and in this publication.

Trimble cannot anticipate every possible circumstance that might involve a potential hazard. The warnings in this publication and on the product are, therefore, not all inclusive. If a tool, procedure, work method or operating technique that is not specifically recommended by Trimble is used, you must satisfy yourself that it is safe for you and for others. You should also ensure that the product will not be damaged or be made unsafe by the operation, lubrication, maintenance or repair procedures that you choose.

The information, specifications, and illustrations in this publication are on the basis of information that was available at the time that the publication was written. The specifications, torques, pressures, measurements, adjustments, illustrations, and other items can change at any time. These changes can affect the service that is given to the product. Obtain the complete and most current information before you start any job. Dealers have the most current information available.

B.4.1 Laser Safety

As with any bright light source, such as the sun, electric welding arcs or arc lamps, common sense applies:

- DO NOT look into the laser aperture when the laser is on.
- Viewing laser output with telescopic optical instruments (for example, telescopes and binoculars) may pose an eye hazard.
- Do not remove any warning signs from the laser.
- Use of a laser transmitter by personnel that are not trained on the product may result in exposure to hazardous laser light.

For further information regarding safe use of lasers, refer to the IEC 60825-1 2007, or the manufacturer's documentation supplied with your laser transmitter.

B.4.2 Magnet Safety

The neodymium magnets supplied with the magnetic display mount are very strong. Handling them with care is necessary to prevent personal injuries, and property damage:

- Pacemakers may be damaged or switch to "Test Mode" in the presence of a strong magnetic force. If a pacemaker is in use, keep a minimum of 30 cm (1 foot) distance.
- Be extremely careful when handling the magnets near other magnets or ferrous metal. Losing control of a magnet may result in damage to intervening objects, such as a finger or a cab window.
- Do not remove any warning signs from the magnets.
- The strong magnetic fields of the magnets can damage electronic devices such as hearing aids, items that rely on magnetic storage media such as credit cards, bank cards, and computers, and items containing ferromagnetic components such as mechanical watches.

B.4.3 Crushing prevention and cutting prevention

Support the equipment properly when you work beneath the equipment. Do not depend on the hydraulic cylinders to hold up the equipment. An attachment can fall if a control is moved, or if a hydraulic line breaks.

Unless you are instructed otherwise, never attempt adjustments while the machine is moving. Also, never attempt adjustments while the engine is running.

Whenever there are attachment control linkages, the clearance in the linkage area will increase or the clearance in the linkage area will decrease with movement of the attachment. Stay clear of all rotating and moving parts.

Keep objects away from moving fan blades. The fan blade will throw objects or cut objects.

Do not use a kinked wire cable or a frayed wire cable. Wear gloves when you handle wire cable.

When you strike a retainer pin with force, the retainer pin can fly out. The loose retainer pin can injure personnel. Make sure that the area is clear of people when you strike a retainer pin. In order to avoid injury to your eyes, wear protective glasses when you strike a retainer pin.

Chips or other debris can fly off objects when you strike the objects. Make sure that no one can be injured by flying debris before striking any object.

B.4.4 Operation

Clear all personnel from the machine and from the area.

Clear all obstacles from the machine's path. Beware of hazards (wires, ditches, etc).

Be sure that all windows are clean.

Secure the doors and the windows in the open position or in the shut position.

Adjust the rear mirrors (if equipped) for the best visibility close to the machine.

Make sure that the horn, the travel alarm (if equipped), and all other warning devices are working properly.

Fasten the seat belt securely.

Warm up the engine and the hydraulic oil before operating the machine.

Only operate the machine while you are in a seat.

The seat belt must be fastened while you operate the machine. Only operate the controls while the engine is running.

While you operate the machine slowly in an open area, check for proper operation of all controls and all protective devices. Before you move the machine, you must make sure that no one will be endangered.

Do not allow riders on the machine unless the machine has the following equipment:

- Additional seat
- Additional seat belt
- Rollover Protective Structure (ROPS)

Note any needed repairs during machine operation. Report any needed repairs.

Avoid any conditions that can lead to tipping the machine. The machine can tip when you work on hills, on banks and on slopes. Also, the machine can tip when you cross ditches, ridges or other unexpected obstructions.

Avoid operating the machine across the slope. When possible, operate the machine up the slopes and down the slopes.

Maintain control of the machine.

Do not overload the machine beyond the machine capacity.

Be sure that the hitches and the towing devices are adequate.

Never straddle a wire cable. Never allow other personnel to straddle a wire cable.

Before you maneuver the machine, make sure that no personnel are between the machine and the trailing equipment.

Always keep the Rollover Protective Structure (ROPS) installed during machine operation.

Monitor the location of mounted components. Ensure that the components do not come into contact with other parts of the machine during operation.

B.4.5 Exposure to radio frequency (RF) signals

This system uses devices that contain radio transmitters and receivers. The radiated output power is far below the international radio frequency exposure limits. These limits are part of comprehensive guidelines and establish permitted levels of RF energy for the general population. The guidelines are based on the safety standards previously set by international standards bodies:

- American National Standards Institute (ANSI) IEEE. C95.1-1992.
- National Council on Radiation Protection and Measurement (NCRP). Report 86. 1986.
- Int'l Commission on Non-Ionizing Radiation Protection (ICNIRP) 1996.
- Ministry of Health (Canada), Safety Code 6. The standards include a substantial safety margin designed to assure the safety of all persons, regardless of age and health.

Use of unauthorized or modified antennas may impair signal quality and damage a device, causing loss of performance. To assure optimal performance, and ensure human exposure to RF energy is within the guidelines set forth in the relevant standards, always use a device in its normal-use position.

Maintain a minimum 20 cm distance from radio transmitters when they are in use. Avoiding contact with the antenna area when a device is IN USE optimizes the antenna performance.

Exposure to radio frequency radiation from Bluetooth and WLAN transmitters

Devices are approved as a portable devices with respect to Radio Frequency (RF) exposure compliance. The radiated output power of the internal wireless radio transmitters is less than 100 milliwatt, which results in exposure levels far below the FCC radio frequency exposure limits, even when operated in close proximity to the body. The internal wireless radios operate within guidelines found in international radio frequency safety standards and recommendations, which reflect the consensus of the international scientific community. Trimble therefore believes the internal wireless radios are safe for use by users. The level of electromagnetic energy emitted is hundreds of times lower than the electromagnetic energy emitted by wireless devices such as mobile phones. However, the use of wireless radios may be restricted in some situations or environments, such as on aircraft. If you are unsure of restrictions, you are encouraged to ask for authorization before turning on the wireless radios.

Exposure to radio frequency radiation from cellular wireless transmitters

Devices equipped with wireless cellular modem radios have been designed and manufactured to meet safety requirements for limiting exposure to radio waves. When used in accordance with the instructions set forth in this manual, the equipment has been

independently verified to not exceed the emission limits for safe exposure to radio frequency (RF) energy as specified by the Federal Communications Commission of the U.S. Government in 47 CFR §2.1093. These limits are part of comprehensive guidelines and establish permitted levels of RF energy for the general population. The guidelines are based on standards that were developed by independent scientific organization through periodic and thorough evaluation of scientific studies. The standards include a substantial safety margin designed to assure the safety of all persons, regardless of age and health.

B.4.6 Telecommunications & Internet Association (TIA) information

Hearing Aids: Some digital wireless phones may interfere with some hearing aids. In the event of such interference, you may want to consult your wireless service provider, or call customer service to discuss alternatives.

Pacemakers and Other Medical Devices: The Health Industry Manufacturers Association recommends a minimum separation of six inches be maintained between a handheld wireless phone and a pacemaker to avoid potential interference with the pacemaker. These recommendations are consistent with the independent research by and recommendations of Wireless Technology Research. Persons with pacemakers should use the ear opposite the pacemaker to minimize the potential for interference. Persons with pacemakers should exercise great caution if using a hands-free device such as a headset, as these persons may be at greater risk of the device not maintaining the recommended minimum six inches of separation from the pacemaker. If you have any reason to suspect that interference is taking place, turn the device OFF immediately.

If you use any other personal medical device, consult the manufacturer of your device to determine if they are adequately shielded from external RF energy. Your physician may be able to assist you in obtaining this information.

Turn the device OFF in health care facilities when any regulations posted in these areas instruct you to do so. Hospitals or health care facilities may be using equipment that could be sensitive to external RF energy.

B.4.7 Warnings



WARNING — When replacement parts are required for this product Trimble recommends using Trimble replacement parts or parts with equivalent specifications including, but not limited to, physical dimensions, type, strength and material. Failure to heed this warning can lead to premature failures, product damage, personal injury or death.



WARNING — Disconnect the negative battery terminal before commencing any welding. Ensure that power is removed from the system by disconnecting the power input cable(s). Failure to follow this warning may result in electric shock.



WARNING – Do not weld on or drill into any part of the machine's Roll Over Protection Structure (ROPS) as this could weaken its structural integrity.



WARNING — When transporting machines with removable sensors such as GNSS receivers or UTS targets installed, if the sensor mounting bracket clamp loosens, then the sensor may be dislodged from the machine which may result in injury or death. Always remove and store removable sensors prior to transport.



WARNING — When removing or installing removable sensors such as GNSS receivers or UTS targets, if the sensor is accessed improperly, then a fall may result in injury or death. Always follow site, state or national Health and Safety guidelines when removing or installing removable sensors.



WARNING — The magnets on the magnetic display mount are strong. If parts of your hands get between two magnets when you move them, the magnets may suddenly move and pinch or clamp the skin. When the magnets are close together, position your hands so they are not between the two magnets.



WARNING — If you have a pacemaker and handle the magnetic display mount, the magnet can affect the function of the pacemaker and cause physical harm. Remain at least 30 cm (1 foot) from the magnetic display mount if you have a pacemaker.



WARNING — Before disconnecting electrical components, disconnect the battery cable and attach a Do Not Operate tag in the operator's compartment to inform personnel that the equipment is being worked on. Accidental engine starting can cause injury or death to personnel working on the equipment. To avoid accidental engine starting, place and lock a lock-out box onto the battery terminal.



WARNING — The cutting edge may move abruptly during automatic control system tuning. To avoid injury, when the machine is stationary engage the machine's park brake (if present) and have an operator in the machine cab to supervise the tuning. Maintain adequate clearance from people and objects during the automatic control system tuning.



WARNING — The cutting edge may move without warning when Autos is engaged. These sudden movements could cause injury to anyone near the cutting edge, or damage to an unattended machine. Always put the system in Manual and engage the machine's park brake before you leave the machine, or when somebody is working near the cutting edge.



WARNING – The TD520 display screen is designed to minimize glare in a wide variety of environments. However, when using the display in direct sunlight, there is still the possibility of sun-strike on the screen leading to loss of visibility.



WARNING — Do not stare into the laser beam when the laser transmitter is operating. For more information, refer to the documentation that came with your laser.



WARNING — Entering an avoidance zone could cause personal injury or damage to the machine. Always be aware of nearby avoidance zones when operating a machine.



WARNING — You are responsible for observing safe operating practices. This product does not guarantee error-free avoidance zone guidance.

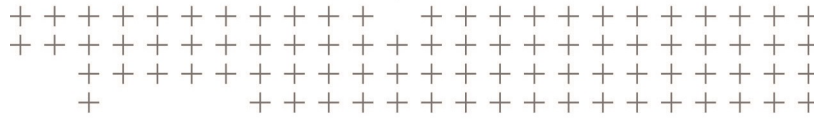

Notices

© 2017 Trimble Incorporated. All rights reserved.

See <https://heavyindustry.trimble.com/earthworksreleases> for the latest:

- Terms and conditions.
- Important safety information.
- Warranty and compliance information.

To provide feedback on this document, email feedback_documentation@trimble.com.